

**MODULAR OFFICE
FURNITURE
PRICE LIST**



Terms & Conditions ①

Finishes ②

Easy Stations ③

Basics ④

Express/Express Plus ⑤

Woodstock ⑥

Reception Desks ⑦

Bookcases, Storage, Wall Units, Carrels ⑧

TERMS AND CONDITIONS:

ORDER INFORMATION All orders are to be in writing to avoid errors and/or duplication. Orders are accepted subject only to the terms and conditions listed hereunder. It is expressly understood that variation from these terms and conditions shall only pertain on a per order basis when agreed to in writing by an officer of HLF Furniture, Incorporated. In placing an order, customer unconditionally agrees that terms and conditions listed hereunder shall supercede any and all terms or conditions listed on the customer's purchase order.

PHONE ORDERS Phone orders must be followed by written confirmation via mail or FAX transmission. It is the customer's responsibility to clearly indicate confirmation to avoid duplication.

ACKNOWLEDGMENT It is our policy to acknowledge all orders in writing. The Acknowledgment will reflect as completely as possible our understanding of the order and will indicate the correct net pricing and approximate ship date. It remains the customer's responsibility to check the Acknowledgment for accuracy and to promptly report any errors or discrepancies.

DATE OF DELIVERY It is our firm intention to comply with requested delivery dates insofar as is reasonably possible; however, it should be recognized that the date of shipment listed on our Acknowledgment is an estimate only and not an essential term of agreement. Delays in shipment of an order do not constitute a valid reason for cancellation nor shall HLF be liable for any expenses arising from any delay in delivery or failure to make delivery due to unavailability of raw materials, labor, or supplies or any factor beyond our reasonable control which might hinder or impede the manufacture or delivery of all or part of any order accepted.

CANCELLATIONS/CHANGES Orders may be cancelled or changed at any time prior to commencement of production. The customer will be responsible for any costs incurred up to the point of cancellation and for the cost of any changes. A minimum cancellation fee of the greater of \$50.00 or two percent of order value will be incurred on any cancelled orders. No cancellations or changes will be accepted after production has commenced.

PRICES All prices are F.O.B. factory, Belleville, Michigan. All prices are subject to change without notice. Orders are accepted at the price in effect as of the date of receipt of order at the factory.

TERMS Terms on price list items are 1% 10 days/net 30 days for customers on open account. Open account is only granted upon approval of a completed HLF Credit Application by our credit department. A 50% deposit or Pro Forma payment may be required prior to processing an initial order. A 50% deposit may be required on custom items regardless of credit status. No orders will be processed for accounts having outstanding invoices more than 30 days past due. Credit terms are conditional upon satisfactory fulfillment of obligations. We reserve the right to revoke credit privileges at any time.

RETURNED CHECKS A returned check charge of \$35.00 will be incurred on any check returned unpaid for any reason.

SPECIFICATIONS Sizes, as listed, are nominal and may vary plus or minus ½" from list. Where product construction and material specifications are listed in this price list, they represent materials and methods in use at the time this list was printed. HLF unconditionally reserves the right to change materials and construction methods without notice as part of our continuing efforts to improve products and techniques. HLF does not manufacture plastic laminates. Specifications for plastic laminate should be obtained directly from the appropriate laminate manufacturers.

RETURNS/RESTOCKING No returns will be accepted without the prior written consent of the factory. As all goods are manufactured to order, there is no provision offered for restocking merchandise upon payment of a restocking charge.

WARRANTY Products are warranted to be free of manufacturing defects — cracks, chips, glue failure, and major scratches. Cracks, chips, and major scratches will be repaired or replaced at no cost only if reported within 48 hours of delivery. Glue failure within five years of delivery will be corrected at no cost to the customer. As gloss, semi-gloss, and dark solid color laminates are subject to minor scratches in any of several production and handling stages, both prior to and during our use of them, we are unable to warrant these finishes completely free of scratches and we suggest they be used discretely. Plastic laminate products, like fine wood products, are subject to environmental conditions. In particular, sustained relative humidity lower than 60 percent may result in cracking of laminate and bowing of doors, prolonged exposure to direct sunlight may reactivate glues and cause delamination, and absorption of standing water may cause substrate swelling. We are unable to accept responsibility for damages resulting from these environmental conditions.

HLF Furniture's sole obligation and customer's remedy under this warranty shall extend to the repair or replacement, at our option, of products which prove defective during the warranty period under normal usage for the purpose intended. Misuse, alteration, negligence, abuse or damage by accident shall negate this warranty. There are no implied warranties of merchantability or fitness for a particular purpose made by HLF in connection with the sale or use of any item. The warranty provisions listed above are expressly in lieu of any other warranties, express or implied by fact or by statute, and all other remedies for damages arising from the sale or use of any item of furniture.

BACKCHARGES Charges incurred by the customer in expediting shipments or for the repair of goods will not be accepted by the company. Any back charges must be approved in advance in writing by HLF Furniture, Inc., via an HLF Credit Memo. We reserve the right to return goods to the factory for warranty repair rather than incur field service costs and shall be liable only for costs between the factory and the destination to which the goods were first delivered as indicated on our Shipper or Bill of Lading.

DROP SHIPMENT Customers desiring drop shipment may arrange for merchandise to be delivered to a local transfer agent capable of delivery to the end-user. Zone 1 customers desiring shipment to a destination other than their own immediate geographic area should consult the factory for possible crating or cartoning charges.

- PACKAGING/CRATING** Shipments made to Zone 1 are generally shipped blanket wrapped. Shipments made to Zone 2 may be either blanket wrapped or packaged depending on order size, geographic location, and other cost considerations. Refer to the inside front cover of this list for Zone definitions and further shipping information for your area. All shipments are F.O.B. factory, Belleville, Michigan. Minimum freight charges for Zone 1 are \$ per delivery.
- CLAIMS** Claims for any damage must be filed promptly with the carrier. In case of damage, any packaging materials should be retained until the goods are inspected. We cannot be responsible for merchandise once a carrier has received and signed for merchandise in good condition.
- STORAGE/DELAYS** When shipment is delayed by the customer, we reserve the right to place the goods in storage at the customer's risk and expense. Terms shall commence upon notification of the customer that goods are ready for pick-up or delivery.
- FINISHES** Prices in this list refer to Standard HLF Laminate Finishes as they may from time to time be designated. Refer to the finish selector chart in this price list for upcharges associated with non-standard finishes.

FINISHES:

GENERAL INFORMATION

All prices in this list, with the exception of Basics, refer to standard HLF laminates. The Palette '95 Swatch Card included in your binder contains actual paper samples of current standard laminates. Additional Swatch Cards may be obtained from your representative, if required.

FINISHES

FINISHES

AS OF MARCH 1, 1995, THE FOLLOWING STANDARD LAMINATES ARE AVAILABLE:

H-21 White	H-62 Port	H-81 Grey Speck
H-23 Antique White	H-63 Burgundy	H-82 Mouse Mix
H-30 Pumice	H-64 Birch Mix	H-83 Charcoal Mix
H-32 Light Blue	H-65 Teal Mix	H-84 Charcoal Dust
H-33 Platinum	H-66 Navy Mix	H-85 White Mix
H-38 Fog	H-67 Sand Mix	H-86 Grey Mix
H-41 Moss Green	H-68 Charcoal Essence	H-87 Grey Dust
H-43 Dutch Blue	H-70 Maple	H-89 Beige Dust
H-45 Birch	H-71 Light Oak	H-90 Firedust
H-48 Pepperdust	H-72 Pear	H-92 Green Mix
H-50 Juniper	H-73 Medium Oak	H-96 Oxide
H-53 English Ivy	H-74 Mahogany	H-99 Black Vortex
H-54 Anthra Green	H-76 Cherry	
H-55 Black	H-80 Blue Grey Mix	

In addition to our standard finishes, we are able to source and use virtually any other laminate finish available. In order to determine appropriate price adjustments associated with non-standard finishes, refer to the following Finish Selector Chart. *Please note that non-standard finishes are not available on the Basics Series.*

ORDER SIZE

LAMINATE BRAND AND FINISH	UNDER \$ PER COLOR— PERCENTAGE UPCHARGE	OVER \$ PER COLOR— PERCENTAGE UPCHARGE
HLF Standard Finishes	As listed	As listed
Pionite Matte Solids and Woodgrains	+10%	As listed
Pionite Gloss	+10%	+10%
Wilson Art Matte Solids and Woodgrains	+10%	As listed
Wilson Art Gloss	+15%	+15%
Formica Matte Solids and Woodgrains	+10%	As listed
Formica Scorpio, Oxide, Patina, Volcano	+15%	+15%
Formica Design Concepts & Lacquer	+35%	+35%
Formica Color Core or equal	Factory Quote Only, any quantity	
Nevamar Textured Solids and Woodgrains	+10%	As listed
Nevamar Gloss Solids, Natural	+15%	+15%
Micarta Matte	+20%	+20%
Laminart Matte	+30%	+30%
Laminart Gloss	+40%	+40%
Metals, Canes, Corks	Factory Quote Only, any quantity	
Other brands	Factory Quote Only, any quantity	
Other finishes (chemical resistant, ESD, dimensional, etc.)	Factory Quote Only, any quantity	
COM laminate, standard grade	No upcharge, no credit	
COM laminate, specialty grade	Factory Quote Only	

BASICS SERIES FINISHES

All Basics Series prices refer to HLF Basics Series finishes. Non-standard finishes are not available with the Basics Series. As of September 1, 1995, the following Basics Series finishes are available:

M-11 White	M-18 Light Oak
M-13 Black	M-19 Medium Oak
M-14 Charcoal Matrix	M-20 Mahogany
M-15 Flax Matrix	M-22 Pumice
M-16 Grey	M-23 Sand Matrix
M-17 Grey Matrix	M-24 White Matrix

QUICK SHIP

HLF Furniture offers the most extensive Quick Ship program in laminate office furniture. The entire Basics Series is available in ten working days in all twelve Basics finishes. The entire Express Series, along with a wide selection of conference tables, bookcases, occasional tables, and other items, are available in ten working days in our eight Quick Ship colors:

H-21 White	H-71 Light Oak
H-38 Fog	H-73 Medium Oak
H-45 Birch	H-82 Mouse Mix
H-55 Black	H-83 Charcoal Mix

Quick Ship products are designated throughout the price list. When placing an order for Quick Ship delivery, be certain that you clearly indicate QUICK SHIP to ensure that it is properly entered.

FABRIC

Products which are clad in fabrics are priced to incorporate standard selections in Guilford FR-701 Series, Pattern 2100.

CLEANING INSTRUCTIONS

Plastic laminate is a durable, serviceable surface that with minimal care will provide many years of worry-free use. Everyday cleaning requires no more than a soft wipe with a damp sponge. Should dirt build up, wash the surface with mild dishwashing liquid or powdered detergent and warm water and a soft cotton cloth; rinse with warm water and dry with a soft cloth. If this should fail to dislodge the build-up, use an all-purpose cleaner or bathroom cleaner (being careful to follow the manufacturer's instructions), rinse with warm water and dry with a soft cloth.

EASY STATIONS:

GENERAL SERIES FEATURES

- Our six most popular configurations pre-packaged in each of our four modular casegoods lines.
- Ordering a station is as simple as selecting a series, a finish, and indicating a station number. For example, Express Series, Easy Station Three, H-38 Fog.
- All Basics stations are available on our Quick Ship program — ten working days — in all twelve Basics colors. Be sure to clearly specify Quick Ship.
- Express stations are available on a Quick Ship basis in the eight standard laminate Quick Ship colors. Again, clearly specify Quick Ship.
- All worksurfaces are 29" AFF executive height. Consult the individual series sections for series and product features and specifications.

TABLE OF CONTENTS

ITEM	PAGE
Station 1	9
Station 2	10
Station 3	11
Station 4	12
Station 5	13
Station 6	14

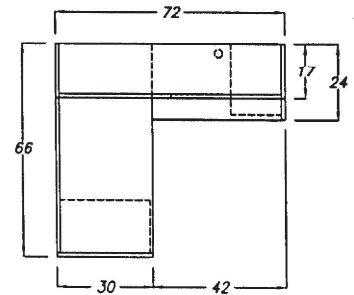
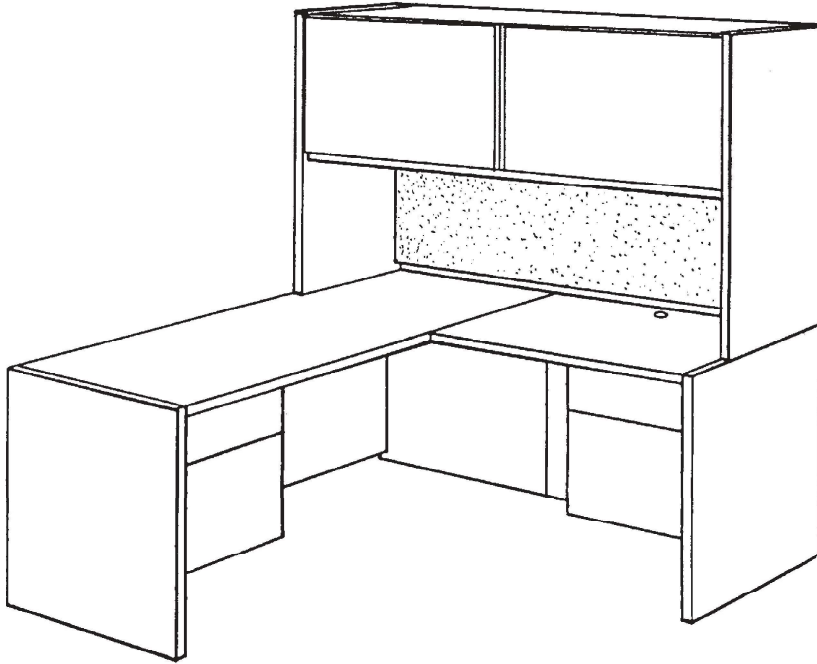

STATION ONE

Footprint: 66"x72"

Specify right hand (R), as illustrated, or left hand (L)

ITEM AND SIZE	WEIGHT	BASICS		EXPRESS		EXPRESSPLUS		WOODSTOCK	
		MODEL NO.	PRICE	MODEL NO.	PRICE	MODEL NO.	PRICE	MODEL NO.	PRICE
66x30x29 desk with box/file pedestal, lock	280	MSPD 6630		XSPD 6630		PSPD 6630		SSPD 6630	
42x24x29 return with box/file pedestal	225	MFE 4224		XFOE 4224		PFOE 4224		SFOE 4224	
grommet, centered on return kneespace		FIGROM		FIGROM		FIGROM		FIGROM	
72x17x36 flipper door overstorage	295	MFDU 7236		XFDU 7236		PFDU 7236		SFDU 7236	
69½x¾x21 tackable panel	15	TACK 7021		TACK 7021		TARK 6721		TACK 7021	
48" tasklight	5	LITE 0048		LITE 0048		LITE 0048		LITE 0048	
STATION LIST PRICE									

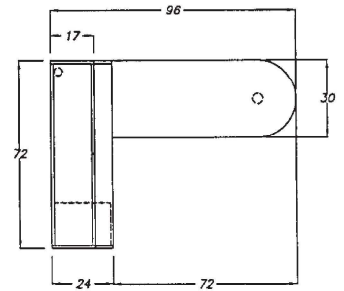
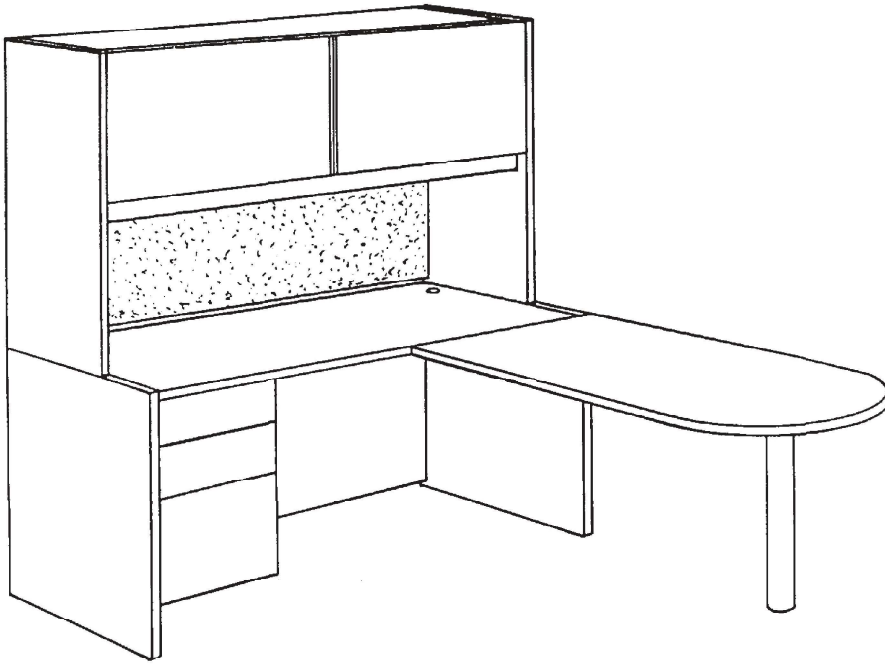

STATION TWO

Footprint: 72"x96"

Specify right hand (R), as illustrated, or left hand (L)

ITEM AND SIZE	WEIGHT	BASICS		EXPRESS		EXPRESSPLUS		WOODSTOCK	
		MODEL NO.	PRICE	MODEL NO.	PRICE	MODEL NO.	PRICE	MODEL NO.	PRICE
72x30x29 bullet runoff with cylinder support	155	MBRO 7230		XBRO 7230		XBRO 7230		SBRO 7230	
72x24x29 desk with box/box/file pedestal with lock	285	MCBF 7224		XCBF 7224		PCBF 7224		SCBF 7224	
grommet, installed back corner of desk		FIGROM		FIGROM		FIGROM		FIGROM	
72x17x36 flipper door overstorage	295	MFDU 7236		XFDU 7236		PFDU 7236		SFDU 7236	
69½x¾x21 tackable panel	10	TACK 7021		TACK 7021		TARK 6721		TACK 7021	
48" tasklight	5	LITE 0048		LITE 0048		LITE 0048		LITE 0048	
STATION LIST PRICE									

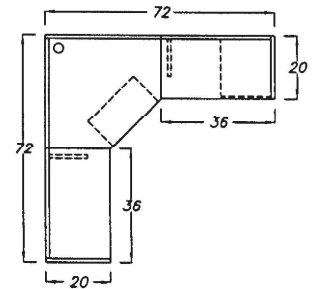
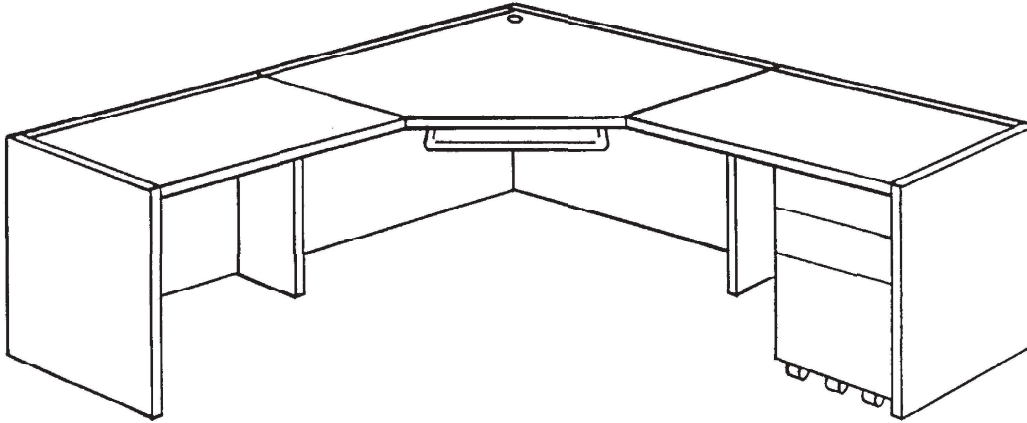

STATION THREE

Footprint: 72"x72"
Unhanded

ITEM AND SIZE	WEIGHT	BASICS		EXPRESS		EXPRESSPLUS		WOODSTOCK	
		MODEL NO.	PRICE	MODEL NO.	PRICE	MODEL NO.	PRICE	MODEL NO.	PRICE
36x20x29 left hand open return	115	MOE 3620L		XOOE 3620L		POOE 3620L		SOOE 3620L	
36x36x29 corner extension, corner grommet	160	MCRE 3636		XCRE 3636		PCRE 3636		SCRE 3636	
36x20x29 right hand open return	115	MOE 3620R		XOOE 3620R		POOE 3620R		SOOE 3620R	
12x1¼x27¾ support panels (2)	30	MSP 1227		XSP 1227		XSP 1227		SSP 1227	
16x18x27½ mobile box/box/file pedestal	85	MMFM 1618		BBFM 1618		BBFM 1618		BBFM 1618	
slide-out keyboard tray	5	ZOK		ZOK		ZOK		ZOK	
STATION LIST PRICE									

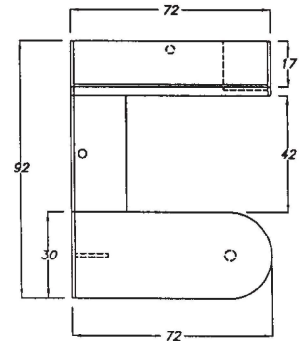
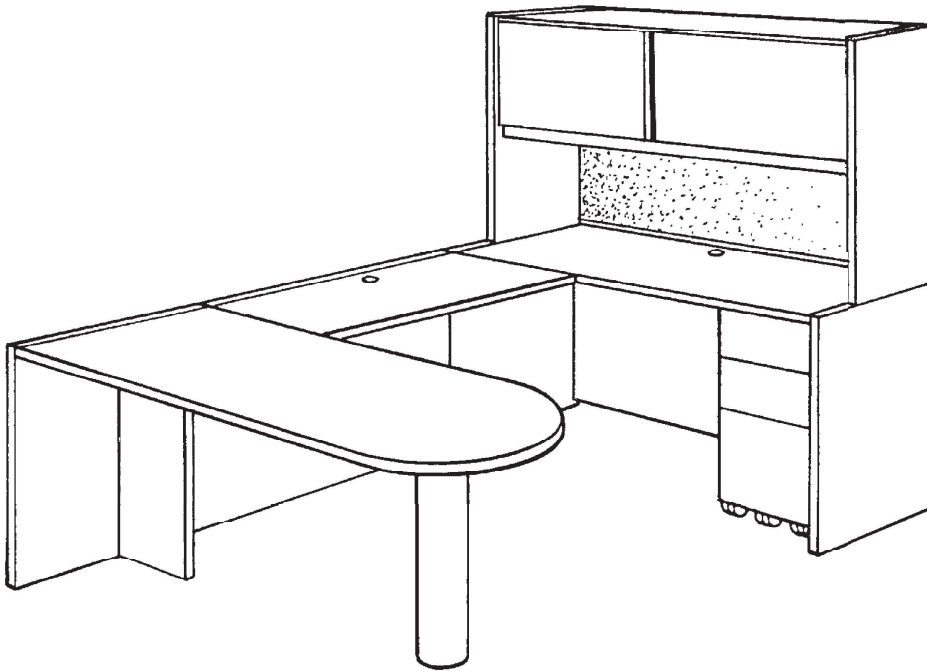

STATION FOUR

Footprint: 72"x92"

Specify right hand (R), as illustrated, or left hand (L)

ITEM AND SIZE	WEIGHT	BASICS		EXPRESS		EXPRESSPLUS		WOODSTOCK	
		MODEL NO.	PRICE	MODEL NO.	PRICE	MODEL NO.	PRICE	MODEL NO.	PRICE
72x30x29 bullet desk with cylinder support	215	MOBD 7230		XOBD 7230		POBD 7230		SOBD 7230	
42x20x29 bridge	110	MRE 4220		XBRE 4220		PBRE 4220		SBRE 4220	
grommet, center back of bridge		FIGROM		FIGROM		FIGROM		FIGROM	
72x20x29 open credenza	220	MOOC 7220		XOOC 7220		POOC 7220		SOOC 7220	
grommet, center back of credenza		FIGROM		FIGROM		FIGROM		FIGROM	
16x18x27½ mobile box/box/file pedestal	85	MMFM 1618		BBFM 1618		BBFM 1618		BBFM 1618	
72x17x36 flipper door overstorage	295	MFDU 7236		XFDU 7236		PFDU 7236		SFDU 7236	
69½x¾x21 tackable panel	10	TACK 7021		TACK 7021		TARK 6721		TACK 7021	
48" tasklight	5	LITE 0048		LITE 0048		LITE 0048		LITE 0048	

STATION LIST PRICE

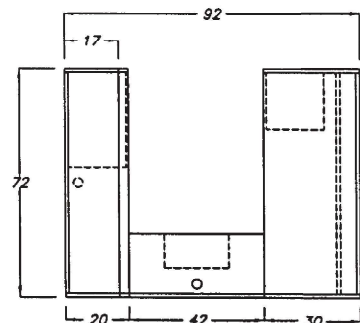
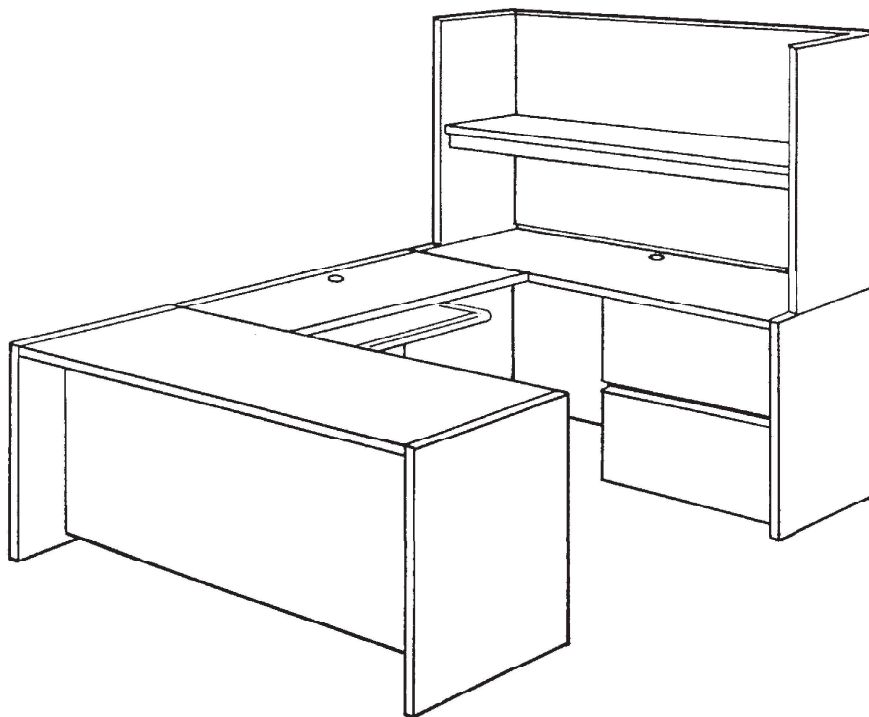

STATION FIVE

Footprint: 72"x92"

Specify right hand (R), as illustrated, or left hand (L)

ITEM AND SIZE	WEIGHT	BASICS		EXPRESS		EXPRESSPLUS		WOODSTOCK	
		MODEL NO.	PRICE	MODEL NO.	PRICE	MODEL NO.	PRICE	MODEL NO.	PRICE
72x30x29 desk with box/box/file pedestal with lock	310	MCBF 7230		XCBF 7230		PCBF 7230		SCBF 7230	
42x20x29 bridge	110	MRE 4220		XBRE 4220		PBRE 4220		SBRE 4220	
grommet, center back of bridge		FIGROM		FIGROM		FIGROM		FIGROM	
72x20x29 credenza with 30" w two drawer lateral file, lock	370	MLOC 7220		XLOC 7220		PLOC 7220		SLOC 7220	
grommet, center back of credenza		FIGROM		FIGROM		FIGROM		FIGROM	
72x17x36 open shelf overstorage	240	MSHU 7236		XSHU 7236		PSHU 7236		SSHU 7236	
slide-out keyboard tray	5	ZOK		ZOK		ZOK		ZOK	
STATION LIST PRICE									

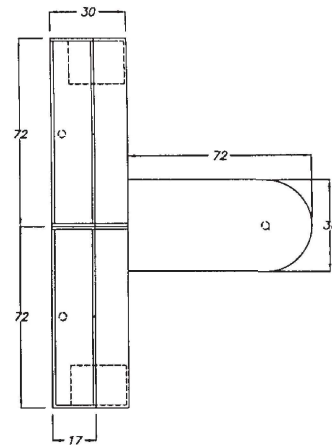
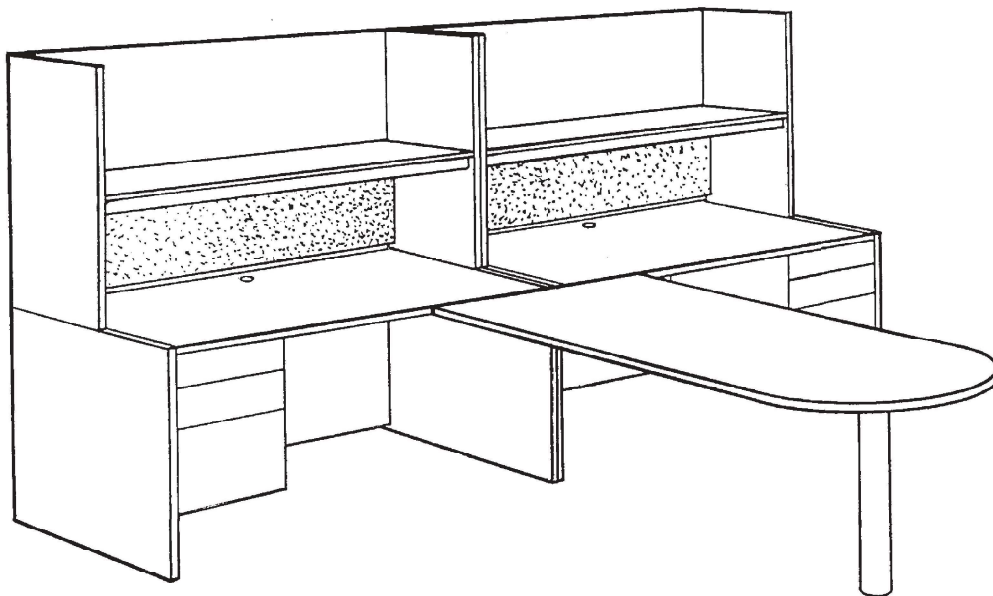

STATION SIX

Footprint: 144"x102"
Unhanded

ITEM AND SIZE	WEIGHT	BASICS		EXPRESS		EXPRESSPLUS		WOODSTOCK	
		MODEL NO.	PRICE	MODEL NO.	PRICE	MODEL NO.	PRICE	MODEL NO.	PRICE
72x30x29 bullet runoff with cylinder support	180	MBRO 7230		XBRO 7230		XBRO 7230		SBRO 7230	
72x30x29 desk with left hand box/box/file pedestal, lock	310	MCBF 7230L		XCBF 7230L		PCBF 7230L		SCBF 7230L	
grommet, center back of desk		FIGROM		FIGROM		FIGROM		FIGROM	
72x30x29 desk with right hand box/box/file pedestal, lock	310	MCBF 7230R		XCBF 7230R		PCBF 7230R		SCBF 7230R	
grommet, center back of desk		FIGROM		FIGROM		FIGROM		FIGROM	
72x17x36 open shelf overstorage (2)	480	MSHU 7236		XSHU 7236		PSHU 7236		SSHU 7236	
69½x¾x21 tackable panel (2)	30	TACK 7021		TACK 7021		TARK 6721		TACK 7021	
48" tasklight (2)	10	LITE 0048		LITE 0048		LITE 0048		LITE 0048	
STATION LIST PRICE									



B A S I C S :

GENERAL SERIES FEATURES

- 1½" slab construction.
- ¾" thick modesty panels on desk units.
- All visible surfaces finished in specified laminate.
- 45 lb. density industrial particle board substrate.
- Leveling glides on all units.
- All wood dowelled drawer construction with black vinyl wrap.
- Accuride® suspensions on file drawers.
- Most vertical file drawers accommodate both letter and legal size hanging folder files. Vertical file drawers on 20"d returns and credenzas file letter only.
- Fully modular construction.
- Blum® hinges on all doors.
- Full case pedestal construction.

TABLE OF CONTENTS

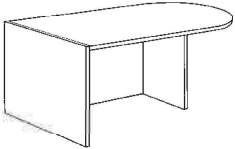
ITEM	PAGE
Credenzas	26
Desks, bullet	16
Desks, double pedestal	25
Desks, reception.....	32
Desks, single pedestal.....	17
Filing cabinets, lateral	27–28
Filing cabinets, mobile	29
Overstorage, worksurface mounted.....	30
Pedestals, freestanding.....	29
Pedestals, mobile.....	29
Returns, corner units	20
Returns, executive height.....	18–20
Returns, reception	32
Returns, secretarial/machine height.....	21–23
Screens.....	31
Tables, computer.....	24
Tables, machine stands	24
Tables, printer	24
Tackable panels.....	30

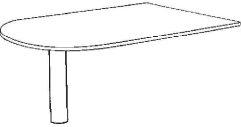
	Size (WDH)	Weight	Model No.	Price	Features
BULLET DESKS					
	60x30x29	175	MOBD 6030		<ul style="list-style-type: none"> • Black 4" dia. metal cylinder support • Unhanded — accepts left or right return • 12" support panel centered on leg
	66x30x29	185	MOBD 6630		
	72x30x29	195	MOBD 7230		
	72x36x29	210	MOBD 7236		
<hr/>					
	60x30x29	200	MMBD 6030L		<ul style="list-style-type: none"> • Full modesty panel • Accepts left hand return
	66x30x29	215	MMBD 6630L		
	72x30x29	225	MMBD 7230L		
	72x36x29	245	MMBD 7236L		
<hr/>					
	60x30x29	200	MMBD 6030R		<ul style="list-style-type: none"> • Full modesty panel • Accepts right hand return
	66x30x29	215	MMBD 6630R		
	72x30x29	225	MMBD 7230R		
	72x36x29	245	MMBD 7236R		
<hr/>					
BULLET RUNOFF DESKS					
	60x30x29	135	MBRO 6030		<ul style="list-style-type: none"> • Unhanded • Not for freestanding applications • Attaches to adjacent unit with heavy-duty metal flat plate • Black 4" dia. metal cylinder support
	66x30x29	145	MBRO 6630		
	72x30x29	155	MBRO 7230		

NOTE: Basics Series products are only available in Basics Finishes. These are designated with the prefix M-XX, and are listed on page 7 of the price list.

 Denotes Quick Ship item. Available on Quick Ship in all Basics finishes.

OPTIONS

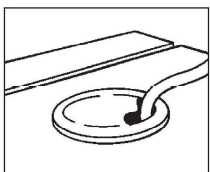

Grommet
FIGROM(x) — \$
indicate location

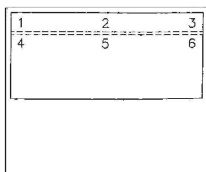

Grommet Locator

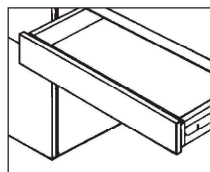

Pencil Drawer
PD — \$

Size (wdh)	Weight	Model No.	Price	Features
------------	--------	-----------	-------	----------

SINGLE PEDESTAL DESKS

48" w desks will not accept returns, 60" w desk will not accept 24" d returns.

	48x24x29	205	MSPD 4824L	<ul style="list-style-type: none"> • Left hand pedestal • Accepts right hand return • 1 box, 1 file drawer • Drop lock included • Full modesty panel recessed 6", except 24" d has flush panel
	48x30x29	225	MSPD 4830L	
	60x24x29	230	MSPD 6024L	
	60x30x29	250	MSPD 6030L	
	66x24x29	235	MSPD 6624L	
	66x30x29	255	MSPD 6630L	
	72x24x29	245	MSPD 7224L	
	72x30x29	265	MSPD 7230L	
	72x36x29	285	MSPD 7236L	

	48x24x29	205	MSPD 4824R	<ul style="list-style-type: none"> • Right hand pedestal • Accepts left hand return • 1 box, 1 file drawer • Drop lock included • Full modesty panel recessed 6", except 24" d has flush panel
	48x30x29	225	MSPD 4830R	
	60x24x29	230	MSPD 6024R	
	60x30x29	250	MSPD 6030R	
	66x24x29	235	MSPD 6624R	
	66x30x29	255	MSPD 6630R	
	72x24x29	245	MSPD 7224R	
	72x30x29	265	MSPD 7230R	
	72x36x29	285	MSPD 7236R	

	48x24x29	230	MCBF 4824L	<ul style="list-style-type: none"> • Left hand pedestal • Accepts right hand return • 2 box, 1 file drawer • Drop lock included • Full modesty panel recessed 6", except 24d has flush panel
	48x30x29	250	MCBF 4830L	
	60x24x29	245	MCBF 6024L	
	60x30x29	265	MCBF 6030L	
	66x24x29	255	MCBF 6624L	
	66x30x29	275	MCBF 6630L	
	72x24x29	260	MCBF 7224L	
	72x30x29	280	MCBF 7230L	
	72x36x29	305	MCBF 7236L	

	48x24x29	230	MCBF 4824R	<ul style="list-style-type: none"> • Right hand pedestal • Accepts left hand return • 2 box, 1 file drawer • Drop lock included • Full modesty panel recessed 6", except 24" d has flush panel
	48x30x29	250	MCBF 4830R	
	60x24x29	245	MCBF 6024R	
	60x30x29	265	MCBF 6030R	
	66x24x29	255	MCBF 6624R	
	66x30x29	275	MCBF 6630R	
	72x24x29	260	MCBF 7224R	
	72x30x29	280	MCBF 7230R	
	72x36x29	305	MCBF 7236R	

	48x24x29	130	MTDK 4824	<ul style="list-style-type: none"> • Open desk shell • 18" modesty panel recessed 6", except 24" d has flush panel
	48x30x29	150	MTDK 4830	
	60x30x29	165	MTDK 6030	
	66x30x29	175	MTDK 6630	
	72x30x29	180	MTDK 7230	
	72x36x29	205	MTDK 7236	

NOTE: Basics Series products are only available in Basics Finishes. These are designated with the prefix M-XX, and are listed on page 7 of the price list.

OPTIONS

Denotes Quick Ship item. Available on Quick Ship in all Basics finishes.

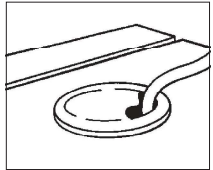

Grommet
FIGROM(x) — \$
indicate location

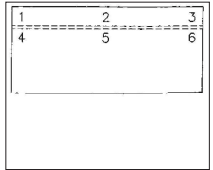

Grommet Locator

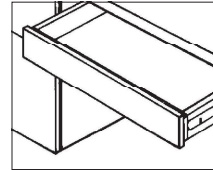

Pencil Drawer
PD — \$

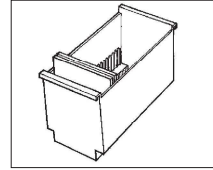

File Drawer Media Bin
holds 24 CD-ROM or
56 3½" Floppy Disks
MB — \$

Size (WDH) Weight Model No. Price Features

EXECUTIVE RETURNS

Worksurface height 29" AFF.

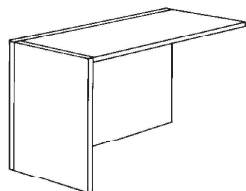

OPEN RETURNS—LEFT HAND

30x20x29	100	MOE 3020L
36x20x29	105	MOE 3620L
42x20x29	120	MOE 4220L
48x20x29	125	MOE 4820L
60x20x29	150	MOE 6020L

30x24x29	110	MOE 3024L
36x24x29	115	MOE 3624L
42x24x29	130	MOE 4224L
48x24x29	140	MOE 4824L
60x24x29	165	MOE 6024L

36x30x29	145	MOE 3630L
42x30x29	160	MOE 4230L
48x30x29	175	MOE 4830L
60x30x29	200	MOE 6030L

- 60" w units have 15" d support leg centered on width
- Use with extra deep corner extensions

OPEN RETURNS—RIGHT HAND

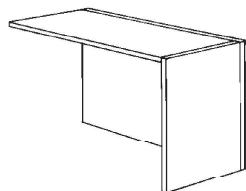

30x20x29	100	MOE 3020R
36x20x29	105	MOE 3620R
42x20x29	120	MOE 4220R
48x20x29	125	MOE 4820R
60x20x29	150	MOE 6020R

30x24x29	110	MOE 3024R
36x24x29	115	MOE 3624R
42x24x29	130	MOE 4224R
48x24x29	140	MOE 4824R
60x24x29	165	MOE 6024R

36x30x29	145	MOE 3630R
42x30x29	160	MOE 4230R
48x30x29	175	MOE 4830R
60x30x29	200	MOE 6030R

- 60" w units have 15" d support leg centered on width
- Use with extra deep corner extensions

NOTE: Basics Series products are only available in Basics Finishes. These are designated with the prefix M-XX, and are listed on page 7 of the price list.

■ Denotes Quick Ship item. Available on Quick Ship in all Basics finishes.

Special Widths and Depths:

For in-between widths, specify letter code of desired model followed by SPECIAL (i.e., MOS-SPECIAL) and indicated desired size — add 10% to price of next largest standard size. For in-between or custom depths, consult factory for availability, specification and pricing information.

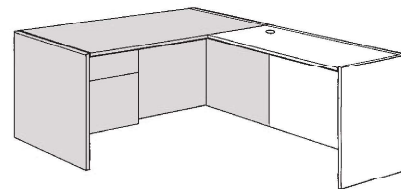

OPTIONS

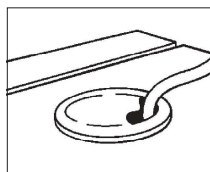

Grommet
FIGROM(x) — \$
indicate location

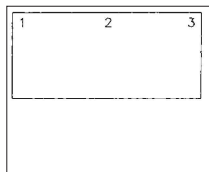

Grommet Locator

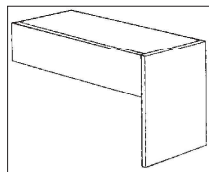

Short Back Panel—8" h
8HI — \$

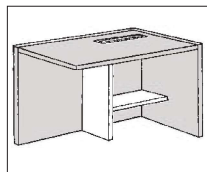

Printer Kit: 12" Side Panel,
24"x12" Shelf, Paper Slot
P-KIT — \$

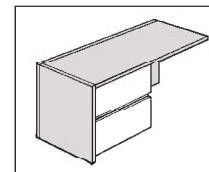

2 Drawer Lateral File,
30" w installed in MOE
LFO30 — \$

Size (WDH)	Weight	Model No.	Price	Features
------------	--------	-----------	-------	----------

EXECUTIVE RETURNS

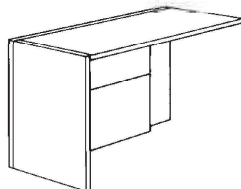

RETURNS WITH BOX, FILE PEDESTALS—LEFT HAND

36x20x29	165	MFE 3620L
42x20x29	180	MFE 4220L
48x20x29	185	MFE 4820L
60x20x29	210	MFE 6020L

- Box/box/file Pedestal
specify MFE-BBF — add \$
- File/File Pedestal
specify MFE-FF — add \$

36x24x29	175	MFE 3624L
42x24x29	190	MFE 4224L
48x24x29	200	MFE 4824L
60x24x29	225	MFE 6024L

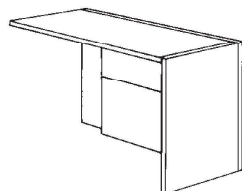

RETURNS WITH BOX, FILE PEDESTALS—RIGHT HAND

36x20x29	165	MFE 3620R
42x20x29	180	MFE 4220R
48x20x29	185	MFE 4820R
60x20x29	210	MFE 6020R

- Box/box/file Pedestal
specify MFE-BBF — add \$
- File/File Pedestal
specify MFE-FF — add \$

36x24x29	175	MFE 3624R
42x24x29	190	MFE 4224R
48x24x29	200	MFE 4824R
60x24x29	225	MFE 6024R

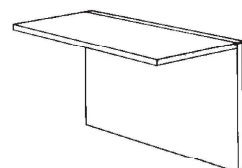

OPEN BRIDGE RETURNS (UNHANDED)

36x20x29	85	MRE 3620
42x20x29	100	MRE 4220
48x20x29	105	MRE 4820
54x20x29	120	MRE 5420
60x20x29	130	MRE 6020

- Units 60" w have half-panel support

36x24x29	95	MRE 3624
42x24x29	110	MRE 4224
48x24x29	120	MRE 4824
54x24x29	135	MRE 5424
60x24x29	145	MRE 6024

- Units 60" w have half-panel support

NOTE: Basics Series products are only available in Basics Finishes. These are designated with the prefix M-XX, and are listed on page 7 of the price list.

■ Denotes Quick Ship item. Available on Quick Ship in all Basics finishes.

Special Widths and Depths:
For in-between widths, specify letter code of desired model followed by SPECIAL (i.e., MOS-SPECIAL) and indicated desired size — add 10% to price of next largest standard size. For in-between or custom depths, consult factory for availability, specification and pricing information.

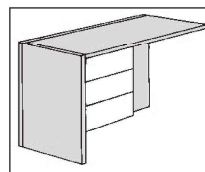

Box/box/file Pedestal
specify MFE-BBF—
add \$

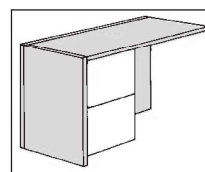

File/file Pedestal
specify MFE-FF—
add \$

OPTIONS

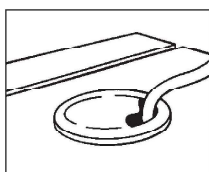

Grommet
FIGROM(x) — \$
indicate location

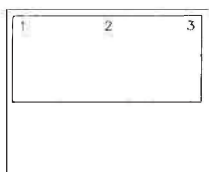

Grommet Locator

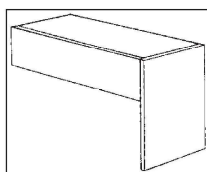

Short Back Panel—8" h
8HI — \$

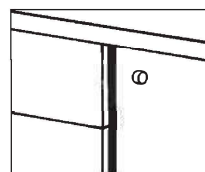

Pedestal Lock
D-LOCK — \$

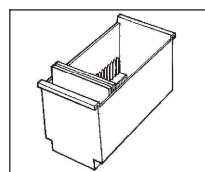

File Drawer Media Bin
holds 24 CD-ROM or
56 3½" Floppy Disks
MB — \$

Size (WDH) Weight Model No. Price Features

EXECUTIVE RETURNS

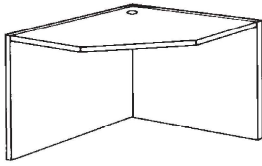

EXECUTIVE HEIGHT CORNER EXTENSIONS

Note: Open extensions are not freestanding. They may be used between two other components or they may be attached to a single other component if a panel end is added to the open end. A panel end will add 1¼" to the size of the unit. Support panels should be added where corner extensions abut open or bridge returns or pedestal returns wider than 48".

36x36x29	145	MCRE 3636
36x42x29	160	MCRE 3642A
42x36x29	160	MCRE 4236B
36x42x29	160	MCRE 3642C
42x36x29	160	MCRE 4236D
42x42x29	175	MCRE 4242

• Corner grommet is standard

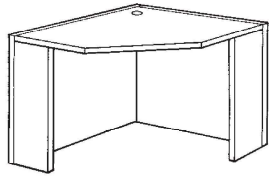
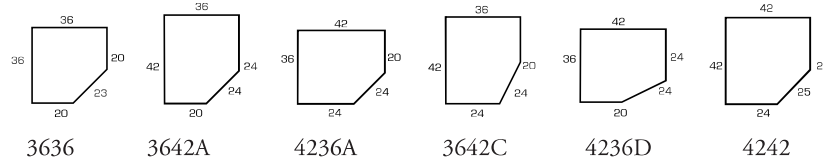

EXTRA DEEP CORNER EXTENSIONS

48x42x29	235	MCRE 4842A
42x48x29	235	MCRE 4248B
48x42x29	235	MCRE 4842C
42x48x29	235	MCRE 4248D
48x48x29	250	MCRE 4848

• Corner grommet is standard
 • 12"d support panel on 24"d ends
 • 15"d support panel on 30"d ends

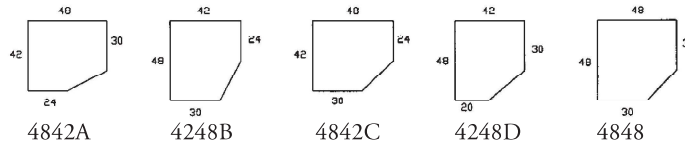

LEGS



20x1½x29	30	MLEG 2029
24x1½x29	35	MLEG 2429
30x1½x29	40	MLEG 3029
36x1½x29	45	MLEG 3629

• Use to finish open end corner extension

SUPPORT PANELS

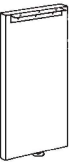

12x1½x27¾	15	MSP 1227
15x1½x27¾	20	MSP 1527

• Use where corner extensions abut open or bridge returns or pedestal returns wider than 48"

NOTE: Basics Series products are only available in Basics Finishes. These are designated with the prefix M-XX, and are listed on page 7 of the price list.

■ Denotes Quick Ship item. Available on Quick Ship in all Basics finishes.

OPTIONS

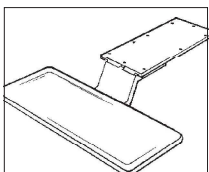

Slide-out Keyboard with Center Mount Slide and Molded Tray
 ZOK — \$

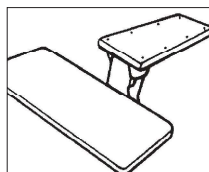

Articulating Keyboard with Molded Tray
 ART-M — \$

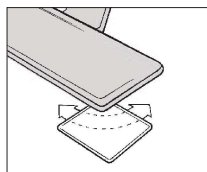

Mouse Pad Extension mounts to ZOK or ART-M MPE — \$

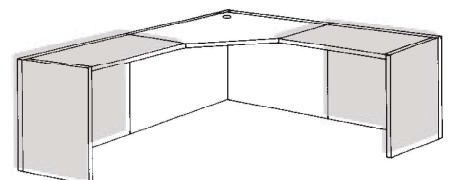

Size (WDH) Weight Model No. Price

SECRETARIAL RETURNS

Worksurface height 26" AFF, 3" h gallery rail.

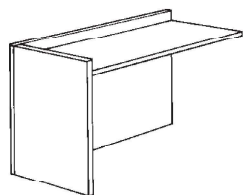

OPEN RETURNS—LEFT HAND

30x20x29	100	MOS 3020L
36x20x29	105	MOS 3620L
42x20x29	120	MOS 4220L
48x20x29	125	MOS 4820L
60x20x29	150	MOS 6020L

30x24x29	110	MOS 3024L
36x24x29	115	MOS 3624L
42x24x29	130	MOS 4224L
48x24x29	140	MOS 4824L
60x24x29	165	MOS 6024L

OPEN RETURNS—RIGHT HAND

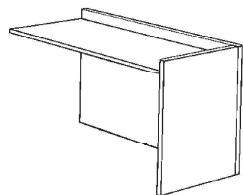

30x20x29	100	MOS 3020R
36x20x29	105	MOS 3620R
42x20x29	120	MOS 4220R
48x20x29	125	MOS 4820R
60x20x29	150	MOS 6020R

30x24x29	110	MOS 3024R
36x24x29	115	MOS 3624R
42x24x29	130	MOS 4224R
48x24x29	140	MOS 4824R
60x24x29	165	MOS 6024R

NOTE: Basics Series products are only available in Basics Finishes. These are designated with the prefix M-XX, and are listed on page 7 of the price list.

■ Denotes Quick Ship item. Available on Quick Ship in all Basics finishes.

BASICS

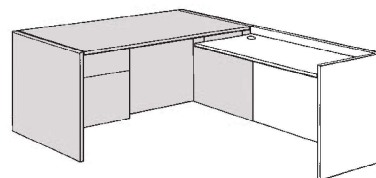

OPTIONS

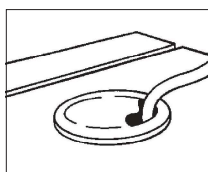

Grommet
FIGROM(x) — \$
indicate location

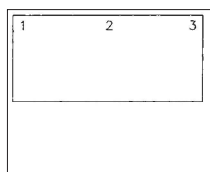

Grommet Locator

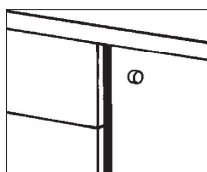

Pedestal Lock
D-LOCK — \$

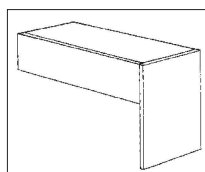

Short Back Panel — 8" h
Available most returns for
wall plug access, specify
8HI — add \$

Special Widths and Depths:

For in-between widths, specify letter code of desired model followed by SPECIAL (i.e., MOS-SPECIAL) and indicated desired size — add 10% to price of next largest standard size. For in-between or custom depths, consult factory for availability, specification and pricing information.

Size (WDH) Weight Model No. Price Features

SECRETARIAL RETURNS

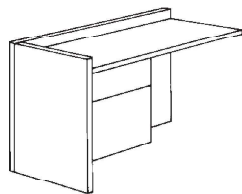

RETURNS WITH BOX, FILE PEDESTALS—LEFT HAND

36x20x29	165	MFS 3620L
42x20x29	180	MFS 4220L
48x20x29	185	MFS 4820L
60x20x29	210	MFS 6020L

36x24x29	175	MFS 3624L
42x24x29	190	MFS 4224L
48x24x29	200	MFS 4824L
60x24x29	225	MFS 6024L

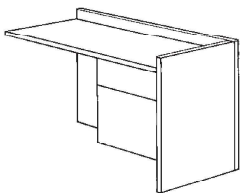

RETURNS WITH BOX, FILE PEDESTALS—RIGHT HAND

36x20x29	165	MFS 3620R
42x20x29	180	MFS 4220R
48x20x29	185	MFS 4820R
60x20x29	210	MFS 6020R

36x24x29	175	MFS 3624R
42x24x29	190	MFS 4224R
48x24x29	200	MFS 4824R
60x24x29	225	MFS 6024R

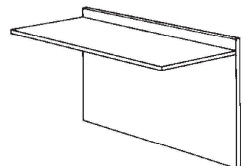

OPEN BRIDGE RETURNS (UNHANDED)

36x20x29	85	MRS 3620
42x20x29	100	MRS 4220
48x20x29	105	MRS 4820
54x20x29	120	MRS 5420
60x20x29	130	MRS 6020

• Units 60" w have half-panel support

36x24x29	95	MRS 3624
42x24x29	110	MRS 4224
48x24x29	120	MRS 4824
54x24x29	135	MRS 5424
60x24x29	145	MRS 6024

NOTE: Basics Series products are only available in Basics Finishes. These are designated with the prefix M-XX, and are listed on page 7 of the price list.

■ Denotes Quick Ship item. Available on Quick Ship in all Basics finishes.

Special Widths and Depths:
For in-between widths, specify letter code of desired model followed by SPECIAL (i.e., MOS-SPECIAL) and indicated desired size — add 10% to price of next largest standard size. For in-between or custom depths, consult factory for availability, specification and pricing information.

OPTIONS

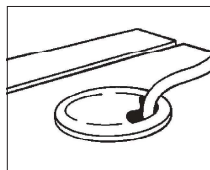

Grommet
FIGROM(x) — \$
indicate location

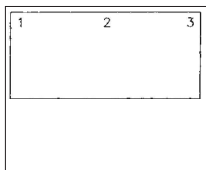

Grommet Locator

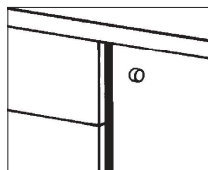

Pedestal Lock
D-LOCK — \$

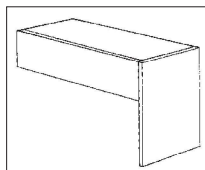

Short Back Panel — 8" h
Available most returns for
wall plug access, specify
8HI — add \$

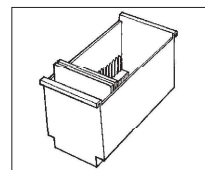

File Drawer Media Bin
holds 24 CD-ROM or
56 3½" Floppy Disks
MB — \$

Size (WDH) Weight Model No. Price Features

SECRETARIAL RETURNS

SECRETARIAL HEIGHT CORNER EXTENSIONS

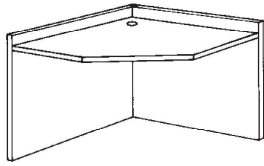

Note: Open extensions are not freestanding. They may be used between two other components or they may be attached to a single other component if a panel end is added to the open end. A panel end will add 1¼" to the size of the unit. Support panels should be added where corner extensions abut open or bridge returns or pedestal returns wider than 48".

36x36x29	145	MCRS 3636
36x42x29	160	MCRS 3642A
42x36x29	160	MCRS 4236B
36x42x29	160	MCRS 3642C
42x36x29	160	MCRS 4236D
42x42x29	175	MCRS 4242

• *Corner grommet is standard*

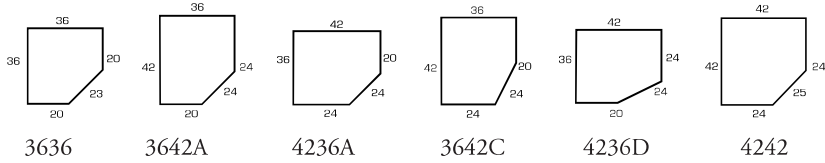

LEGS



20x1½x29	30	MLEG 2029
24x1½x29	35	MLEG 2429
30x1½x29	40	MLEG 3029
36x1½x29	45	MLEG 3629

• *Use to finish open end corner extension*

SUPPORT PANELS



12x1½x24¾	15	MSP 1224
15x1½x24¾	20	MSP 1524

• *Use where corner extensions abut open or bridge returns or pedestal returns wider than 48"*

NOTE: Basics Series products are only available in Basics Finishes. These are designated with the prefix M-XX, and are listed on page 7 of the price list.

■ *Denotes Quick Ship item. Available on Quick Ship in all Basics finishes.*

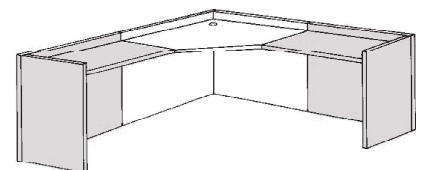

Size (WDH) Weight Model No. Price Features

COMPUTER TABLE / MACHINE STANDS

May be used alone or customized with options to meet specific applications (ex: add printer slot and paper shelf to make a printer stand, add casters and slide-out keyboard tray for mobile terminal table, etc.)

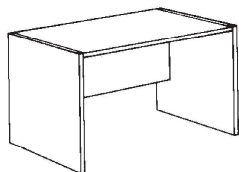

MACHINE HEIGHT UNITS

24x24x26	120	MSCT 2424
30x24x26	130	MSCT 3024
36x24x26	140	MSCT 3624
42x24x26	150	MSCT 4224
48x24x26	160	MSCT 4824
60x24x26	180	MSCT 6024
72x24x26	195	MSCT 7224

• 18" modesty panel inset 1/2" from back

24x30x26	140	MSCT 2430
30x30x26	150	MSCT 3030
36x30x26	160	MSCT 3630
42x30x26	175	MSCT 4230
48x30x26	185	MSCT 4830
60x30x26	210	MSCT 6030
72x30x26	235	MSCT 7230

• 18" modesty panel inset 6" from back

DESK HEIGHT UNITS

24x24x29	125	MSCE 2424
30x24x29	135	MSCE 3024
36x24x29	145	MSCE 3624
42x24x29	155	MSCE 4224
48x24x29	165	MSCE 4824
60x24x29	185	MSCE 6024
72x24x29	200	MSCE 7224

• 18" modesty panel inset 1/2" from back

24x30x29	145	MSCE 2430
30x30x29	155	MSCE 3030
36x30x29	165	MSCE 3630
42x30x29	180	MSCE 4230
48x30x29	190	MSCE 4830
60x30x29	215	MSCE 6030
72x30x29	240	MSCE 7230

• 18" modesty panel inset 6" from back

NOTE: Basics Series products are only available in Basics Finishes. These are designated with the prefix M-XX, and are listed on page 7 of the price list.

■ Denotes Quick Ship item. Available on Quick Ship in all Basics finishes.

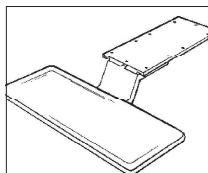

Slide-out Keyboard with Center Mount Slide and Molded Tray
ZOK — \$

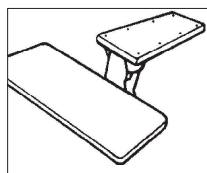

Articulating Keyboard ART-K — \$

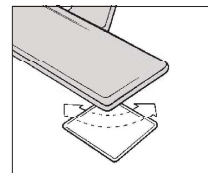

Mouse Pad Extension mounts to ZOK or ART-M MPE — \$

OPTIONS

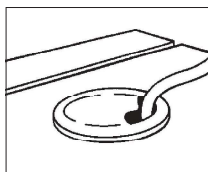

Grommet FIGROM(x) — \$ indicate location

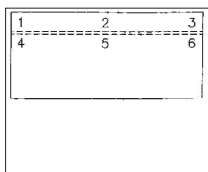

Grommet Locator

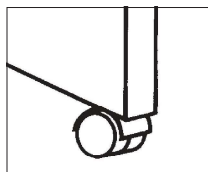

Casters (4) CAST — \$

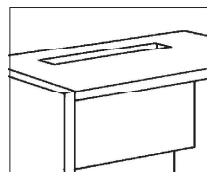

Printer Slot P-Slot — \$

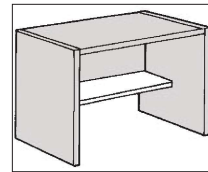

Paper Shelf — 12"d up to 36"w PSU36 — \$ over 36"w PSO36 — \$

	Size (WDH)	Weight	Model No.	Price	Features
DOUBLE PEDESTAL DESKS					
	60x24x29	300	MDPD 6024		<ul style="list-style-type: none"> • 18" modesty panel recessed 6" on 30"d and 36"d desks, 1/2" on 24"d • 3 box left, box/file right • Drop lock on box/file pedestal
	60x30x29	310	MDPD 6030		
	66x24x29	310	MDPD 6624		
	66x30x29	330	MDPD 6630		
	72x24x29	315	MDPD 7224		
	72x30x29	335	MDPD 7230		
72x36x29	355	MDPD 7236			
	60x24x29	325	MCPD 6024		<ul style="list-style-type: none"> • Full modesty panel recessed 6" on 30"d and 36"d desks, 1/2" on 24"d • Box/box/file left, file/file right • Drop lock on file/file pedestal
	60x30x29	345	MCPD 6030		
	66x24x29	335	MCPD 6624		
	66x30x29	355	MCPD 6630		
	72x24x29	340	MCPD 7224		
	72x30x29	365	MCPD 7230		
72x36x29	390	MCPD 7236			

NOTE: Basics Series products are only available in Basics Finishes. These are designated with the prefix M-XX, and are listed on page 7 of the price list.

 Denotes Quick Ship item. Available on Quick Ship in all Basics finishes.

OPTIONS

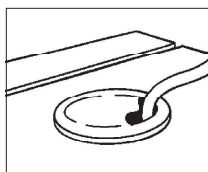

Grommet
FIGROM(x) — \$
indicate location

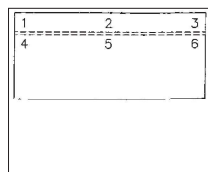

Grommet Locator

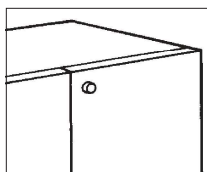

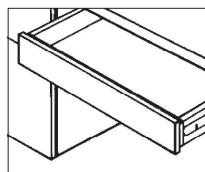

Door Lock
C-LOCK — \$

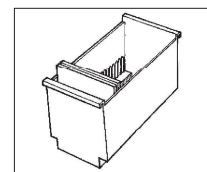

Pencil Drawer
PD — \$

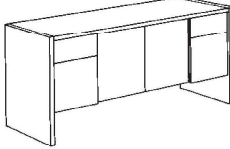
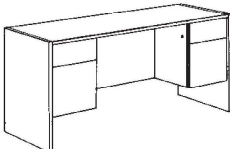
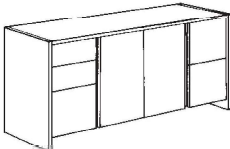

File Drawer Media Bin
holds 24 CD-ROM or
56 3 1/2" Floppy Disks
MB — \$

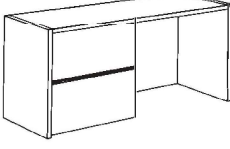
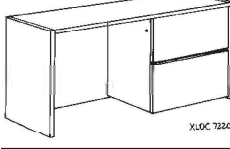
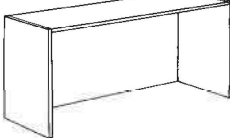
	Size (WDH)	Weight	Model No.	Price	Features
C R E D E N Z A S					
	STORAGE CREDENZA				
	60x20x29	270	MSSC 6020		<ul style="list-style-type: none"> • 2 box, 2 file drawers • Two door cabinet with adjustable shelf • Lock on right hand pedestal
	66x20x29	280	MSSC 6620		
	72x20x29	290	MSSC 7220		
84x20x29	310	MSSC 8420			
	DOUBLE PEDESTAL CREDENZA				
	60x20x29	265	MSOC 6020		<ul style="list-style-type: none"> • 2 box, 2 file drawers • Lock on right hand pedestal
	66x20x29	270	MSOC 6620		
	72x20x29	275	MSOC 7220		
84x20x29	285	MSOC 8420			
	CUBE STYLE CREDENZA				
	60x20x29	305	MCSC 6020		<ul style="list-style-type: none"> • Box/box/file left, file/file right • Two door cabinet with adjustable shelf • Lock on right hand pedestal
	66x20x29	320	MCSC 6620		
	72x20x29	330	MCSC 7220		
84x20x29	360	MCSC 8420			
	FOUR DOOR CREDENZA				
	60x20x29	270	M4DC 6020		<ul style="list-style-type: none"> • Two interior sections • One adjustable shelf per section
	66x20x29	285	M4DC 6620		
	72x20x29	290	M4DC 7220		
84x20x29	320	M4DC 8420			
	LATERAL FILE CREDENZA				
	60x20x29	315	MLOC 6020L		<ul style="list-style-type: none"> • Two 30" w lateral file drawers with lock • 36" w lateral add \$
	66x20x29	330	MLOC 6620L		
	72x20x29	340	MLOC 7220L		
84x20x29	370	MLOC 8420L			
	LATERAL FILE CREDENZA				
	60x20x29	315	MLOC 6020R		<ul style="list-style-type: none"> • Two 30" w lateral file drawers with lock • 36" w lateral add \$
	66x20x29	330	MLOC 6620R		
	72x20x29	340	MLOC 7220R		
84x20x29	370	MLOC 8420R			
	OPEN CREDENZA				
	60x20x29	180	MOOC 6020		<ul style="list-style-type: none"> • Add 18" d universal pedestals from page to create custom single or double pedestal credenzas
	66x20x29	195	MOOC 6620		
	72x20x29	205	MOOC 7220		
84x20x29	215	MOOC 8420			

NOTE: Basics Series products are only available in Basics Finishes. These are designated with the prefix M-XX, and are listed on page 7 of the price list.

 Denotes Quick Ship item. Available on Quick Ship in all Basics finishes.

OPTIONS

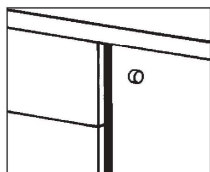

Pedestal Lock
D-LOCK — \$

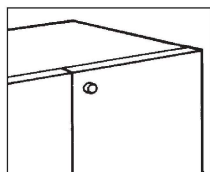

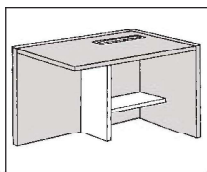

Door Lock
C-LOCK — \$

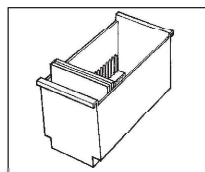

Printer Kit: 12" Side Panel,
24"x12" Shelf, Paper Slot
P-KIT — \$

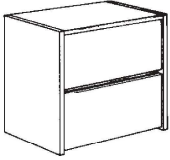
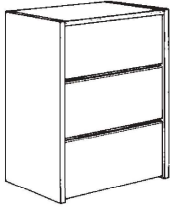

File Drawer Media Bin
holds 24 CD-ROM or
56 3½" Floppy Disks
MB — \$

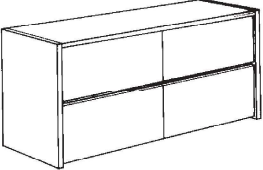
	Size (WDH)	Weight	Model No.	Price	Features
LATERAL FILES — 1 1/8" CASE					
	36x20x29	185	MLFC 3620		<ul style="list-style-type: none"> • Heavy-duty Accuride suspensions • Face mounted gang lock specify F-LOCK2 — add \$
	36x20x43	245	MLF3 3620		<ul style="list-style-type: none"> • Anti-tip mechanism allows only one drawer open at a time • Face mounted gang lock specify F-LOCK3 — add \$
	36x20x57	310	MLF4 3620		<ul style="list-style-type: none"> • Anti-tip mechanism allows only one drawer open at a time • Face mounted gang lock specify F-LOCK4 — add \$
	60x20x29 72x20x29	315 335	MLFC 6020 MLFC 7220		<ul style="list-style-type: none"> • Face mounted gang lock(s) specify F-LOCK2 (L or R) — add \$ per bank (two required to lock all drawers)

NOTE: Basics Series products are only available in Basics Finishes. These are designated with the prefix M-XX, and are listed on page 7 of the price list.

 Denotes Quick Ship item. Available on Quick Ship in all Basics finishes.

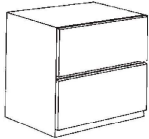
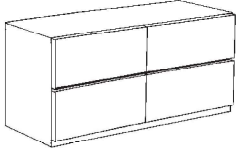
	Size (WDH)	Weight	Model No.	Price	Features
	LATERAL FILES — 3/4" CASE				
	35x20x29	160	MLAC 3620		<ul style="list-style-type: none"> • Heavy-duty Accuride suspensions • Face mounted gang lock specify F-LOCK2 — add \$
	35x20x43	195	MLA3 3620		<ul style="list-style-type: none"> • Anti-tip mechanism allows only one drawer open at a time • Face mounted gang lock specify F-LOCK3 — add \$
	35x20x57	250	MLA4 3620		<ul style="list-style-type: none"> • Anti-tip mechanism allows only one drawer open at a time • Face mounted gang lock specify F-LOCK4 — add \$
	59x20x29	255	MLAC 6020		<ul style="list-style-type: none"> • Face mounted gang lock(s) specify F-LOCK2 (L or R) — add \$ per bank (two required to lock all drawers)
	71x20x29	280	MLAC 7220		

BASICS

NOTE: Basics Series products are only available in Basics Finishes. These are designated with the prefix M-XX, and are listed on page 7 of the price list.

 Denotes Quick Ship item. Available on Quick Ship in all Basics finishes.

	Size (WDH)	Weight	Model No.	Price	Features
--	------------	--------	-----------	-------	----------

PEDESTALS

MOBILE PEDESTALS

All drawer pedestals have fifth caster for stability.

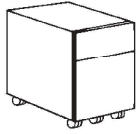

16x18x20½	60	MBFM 1618
16x22x20½	70	MBFM 1622
16x28x20½	80	MBFM 1628

- 1 box, 1 file drawer
- Box drawer includes pencil tray

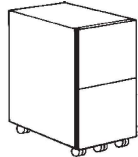

16x18x27	80	MFFM 1618
16x22x27	90	MFFM 1622
16x28x27	100	MFFM 1628

- 2 file drawers



16x18x27	85	MMFM 1618
16x22x27	95	MMFM 1622
16x28x27	105	MMFM 1628

- 2 box, 1 file drawer
- Top box drawer includes pencil tray

UNIVERSAL PEDESTALS

Sized to fit beneath desk height units, stand alone as free-standing units or remove 3" base to retrofit existing units or customize other pieces.

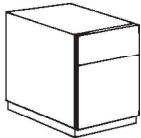

16x18x21	60	MBFU 1618
16x22x21	70	MBFU 1622
16x28x21	80	MBFU 1628

- 1 box, 1 file drawer
- Box drawer includes pencil tray

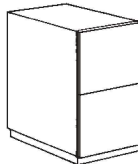

16x18x27½	80	MFFU 1618
16x22x27½	90	MFFU 1622
16x28x27½	100	MFFU 1628

- 2 file drawers

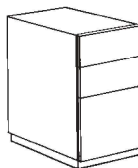

16x18x27½	85	MMFU 1618
16x22x27½	95	MMFU 1622
16x28x27½	105	MMFU 1628

- 2 box, 1 file drawer
- Top box drawer includes pencil tray

NOTE: Basics Series products are only available in Basics Finishes. These are designated with the prefix M-XX, and are listed on page 7 of the price list.

 Denotes Quick Ship item. Available on Quick Ship in all Basics finishes.

OPTIONS

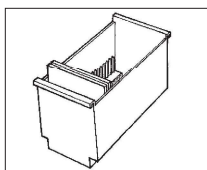

File Drawer Media Bin
holds 24 CD-ROM or
56 3½" Floppy Disks
MB — \$

Size (WDH) Weight Model No. Price Features

OVERSTORAGE COMPONENTS — WORKSURFACE MOUNTED

Attach to lower units with pass-thru clip/shoulder screw Mod-eze clip system. Metal-to-metal connection assures stability and ease of alignment.

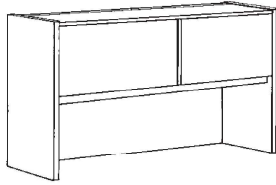

FLIPPER DOOR UNITS

36x17x36	170	MFDU 3636
48x17x36	190	MFDU 4836
60x17x36	230	MFDU 6036
66x17x36	250	MFDU 6636
72x17x36	270	MFDU 7236
78x17x36	290	MFDU 7836
84x17x36	310	MFDU 8436

- 36" and 48" w units have one door, others have two
- Doors slide beneath top for safety and utility
- Accepts 21" tackable acoustically treated panel
- 18" clearance beneath valance

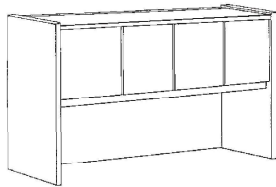

HINGED DOOR UNITS

36x17x36	170	MHDU 3636
48x17x36	190	MHDU 4836
60x17x36	230	MHDU 6036
66x17x36	250	MHDU 6636
72x17x36	270	MHDU 7236
78x17x36	290	MHDU 7836
84x17x36	310	MHDU 8436

- 36" and 48" w units have three doors, others have four
- Accepts 21" tackable acoustically treated panel
- 18" clearance beneath valance
- Self-closing Blum hinges

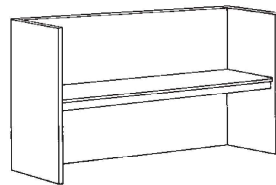

OPEN SHELF UNITS

36x17x36	140	MSHU 3636
48x17x36	160	MSHU 4836
60x17x36	180	MSHU 6036
66x17x36	200	MSHU 6636
72x17x36	220	MSHU 7236
78x17x36	240	MSHU 7836
84x17x36	260	MSHU 8436

- Accepts 21" tackable acoustically treated panel
- 18" clearance beneath valance

TACKABLE PANELS



33½x¾x21	5	TACK 3421
45½x¾x21	5	TACK 4621
57½x¾x21	10	TACK 5821
63½x¾x21	10	TACK 6421
69½x¾x21	15	TACK 7021
75½x¾x21	15	TACK 7621
81½x¾x21	15	TACK 8221

- Use with overstorage units for tackability, acoustical effect
- Available in Guilford 701 Series, Pattern 2100

NOTE: Basics Series products are only available in Basics Finishes. These are designated with the prefix M-XX, and are listed on page 7 of the price list.

■ Denotes Quick Ship item. Available on Quick Ship in all Basics finishes.

OPTIONS

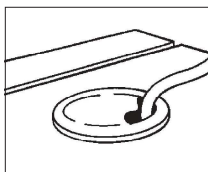

Grommet
FIGROM(x) — \$
indicate location

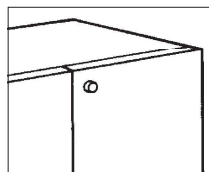

Door Lock
C-LOCK — \$

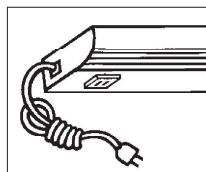

Task light
LITE0024 24" w — \$
LITE0048 48" w — \$

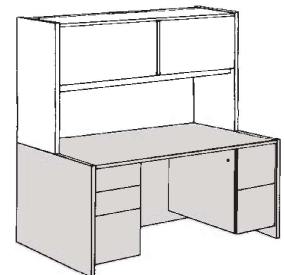
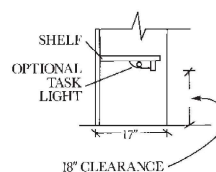

Size (WDH) Weight Model No. Price COM*

S C R E E N S

Screens may be combined with any of the modular casegood items in the Basics Series to provide visual and acoustical privacy. Screens mount easily into end panels and worksurfaces with a heavy-duty steel post mechanism. They may be readily removed to provide conferencing capabilities. Pricing is based on Guilford 701 Series fabrics, Pattern 2100. *Note:* For in-between sizes, use next largest size for pricing.

15" HIGH SCREENS



20x1¼x15	9	SCRN 2015	½ yd
24x1¼x15	10	SCRN 2415	½ yd
30x1¼x15	13	SCRN 3015	½ yd
36x1¼x15	15	SCRN 3615	1 yd
42x1¼x15	18	SCRN 4215	1 yd
48x1¼x15	20	SCRN 4815	1 yd
54x1¼x15	23	SCRN 5415	1 yd
60x1¼x15	25	SCRN 6015	1 yd
66x1¼x15	28	SCRN 6615	2 yd
72x1¼x15	30	SCRN 7215	2¼ yd

22" HIGH SCREENS

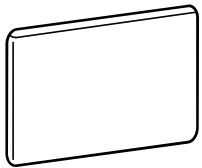

20x1¼x22	13	SCRN 2022	¾ yd
24x1¼x22	15	SCRN 2422	¾ yd
30x1¼x22	19	SCRN 3022	¾ yd
36x1¼x22	22	SCRN 3622	1½ yd
42x1¼x22	26	SCRN 4222	1½ yd
48x1¼x22	30	SCRN 4822	1½ yd
54x1¼x22	33	SCRN 5422	1½ yd
60x1¼x22	37	SCRN 6022	1½ yd
66x1¼x22	41	SCRN 6622	2 yd
72x1¼x22	44	SCRN 7222	2¼ yd

36" HIGH SCREENS

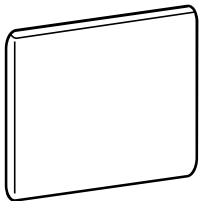

20x1¼x36	20	SCRN 2036	1¼ yd
24x1¼x36	24	SCRN 2436	1¼ yd
30x1¼x36	30	SCRN 3036	1¼ yd
36x1¼x36	36	SCRN 3636	2¼ yd
42x1¼x36	42	SCRN 4236	2¼ yd
48x1¼x36	48	SCRN 4836	2¼ yd
54x1¼x36	54	SCRN 5436	2¼ yd
60x1¼x36	60	SCRN 6036	2¼ yd
66x1¼x36	66	SCRN 6636	4¼ yd
72x1¼x36	72	SCRN 7236	4½ yd

*COM yardage based on 66" w, non-directional fabric. COM material must be approved by HLF before an order can be accepted. All COM material must be shipped to HLF prepaid.

■ Denotes Quick Ship item. Available on Quick Ship in all Basics finishes.

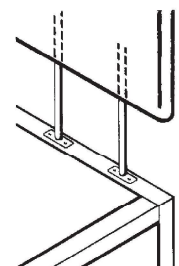
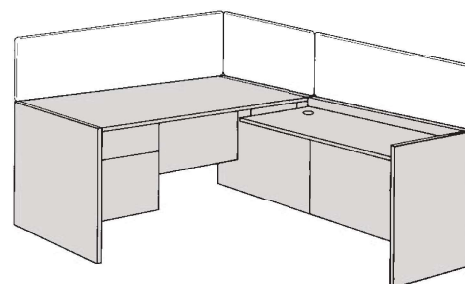

Size (WDH) Weight Model No. Price Features

RECEPTION STATIONS

DESK SHELLS WITH 6" RECESSED FACE PANEL

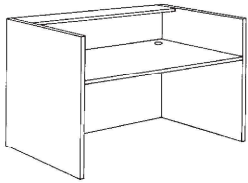

60x30x42	230	MRED 6030
66x30x42	290	MRED 6630
72x30x42	300	MRED 7230
72x36x42	340	MRED 7236

- 10" d transaction ledge
- 29" AFF worksurface
- Grommet each side
- Unhanded — accepts left or right return
- 30" d units accept 22" d pedestals — see p. 29
- 36" d units accept 28" d pedestals — see p. 29

DESK SHELLS WITH 1/4" RECESSED FACE PANEL

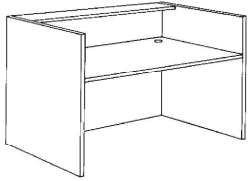

60x30x42	230	MFED 6030
66x30x42	290	MFED 6630
72x30x42	300	MFED 7230
72x36x42	340	MFED 7236

- 10" d transaction ledge
- 29" AFF worksurface
- Grommet each side
- Unhanded — accepts left or right return
- Accept 28" d pedestals — see p. 29

RETURNS—LEFT HAND

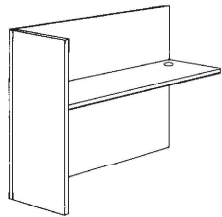

36x20x42	150	MROL 3620
42x20x42	160	MROL 4220
48x20x42	170	MROL 4820
60x20x42	200	MROL 6020

- 29" AFF worksurface
- Grommet
- Accepts 18" d pedestal — see p. 29

36x24x42	160	MROL 3624
42x24x42	170	MROL 4224
48x24x42	180	MROL 4824
60x24x42	210	MROL 6024

- Accepts 22" d pedestal — see p. 29

RETURNS—RIGHT HAND

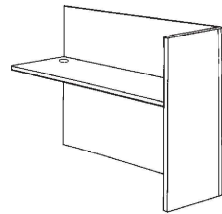

36x20x42	150	MROR 3620
42x20x42	160	MROR 4220
48x20x42	170	MROR 4820
60x20x42	200	MROR 6020

- 29" AFF worksurface
- Grommet
- Accepts 18" d pedestal — see p. 29

36x24x42	160	MROR 3624
42x24x42	170	MROR 4224
48x24x42	180	MROR 4824
60x24x42	210	MROR 6024

NOTE: Basics Series products are only available in Basics Finishes. These are designated with the prefix M-XX, and are listed on page 7 of the price list.

Denotes Quick Ship item. Available on Quick Ship in all Basics finishes.

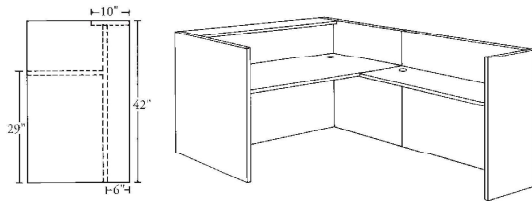

OPTIONS

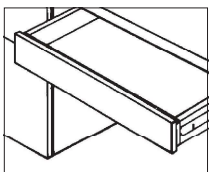

Pencil Drawer
PD — \$

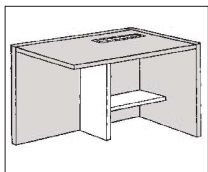

Printer Kit: 12" Side Panel,
24"x12" Shelf, Paper Slot
P-KIT — \$

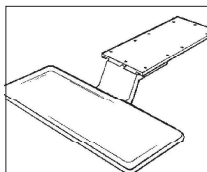

Slide-Out Keyboard
with Center Mount
Slide and Molded Tray
ZOK — \$

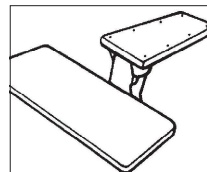

Articulating Keyboard
with Molded Tray
ART-M — \$

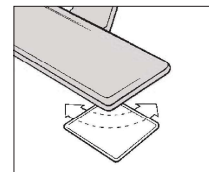

Mouse Pad Extension
mounts to ZOK or
ART-M MPE — \$

EXPRESS / EXPRESS PLUS:

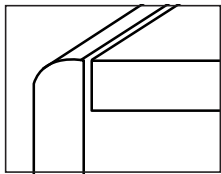
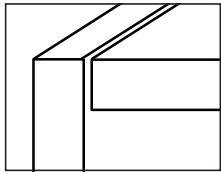

GENERAL SERIES FEATURES

- 1 1/4" slab construction.
- All visible surfaces finished in specified laminate.
- 45 lb. density industrial particle board substrate.
- Leveling glides on all units.
- All wood dowelled drawer construction with black vinyl wrap.
- Accuride® suspensions on all drawers.
- Most vertical file drawers accommodate both letter and legal size hanging folder files. Vertical file drawers on 20"d returns and credenzas file letter only.
- Fully modular construction.
- Blum® hinges on all doors.
- Full case pedestal construction.
- Express Series (Xxxx) has squared end panels.
- ExpressPlus (Pxxx) has radiused end panels and replaces the Radius Series. Some design changes have been affected which differentiate ExpressPlus from Radius.
- Black reveals are standard on all units. Bright Brass (BB) and Mirror Chrome (MC) reveals are available. Specify the appropriate model number with the trim suffix —for example, XOBDD 6030-BB for a 60x30 bullet desk with bright brass trim (add \$ list per piece.)

TABLE OF CONTENTS

ITEM	PAGE
Cabinets, storage.....	52
Credenzas.....	50
Desks, bullet.....	34
Desks, conference.....	35
Desks, double pedestal.....	49
Desks, reception.....	58
Desks, single pedestal.....	36-38
Filing cabinets, lateral.....	51-52
Filing cabinets, mobile.....	53
Overstorage, wall mounted.....	56
Overstorage, worksurface mounted.....	55
Pedestals, freestanding.....	54
Pedestals, mobile.....	53
Returns, corner units.....	42, 44
Returns, executive height.....	38-42
Returns, reception.....	58
Returns, secretarial/machine height.....	43-47
Screens.....	57
Tables, computer.....	48
Tables, machine stands.....	48
Tables, printer.....	48
Tackable panels.....	56



Express



ExpressPlus

Size (WDH) Weight Model No. Price Model No. Price Features

BULLET DESKS

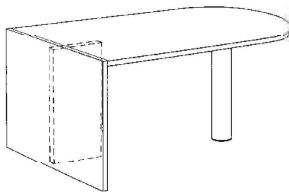

60x30x29	195	XOBD 6030
66x30x29	205	XOBD 6630
72x30x29	215	XOBD 7230
72x36x29	230	XOBD 7236

POBD 6030
POBD 6630
POBD 7230
POBD 7236

- 6" diameter black metal cylinder support
- 12" support panel centered on leg
- Unhanded — accepts left or right return
- 12" diameter laminated cylinder support — LCS add

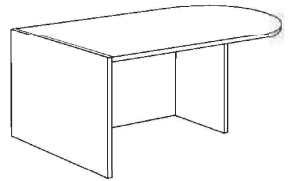

60x30x29	220	XMBD 6030L
66x30x29	235	XMBD 6630L
72x30x29	245	XMBD 7230L
72x36x29	265	XMBD 7236L

PMBD 6030L
PMBD 6630L
PMBD 7230L
PMBD 7236L

- Full modesty panel
- Accepts left hand return

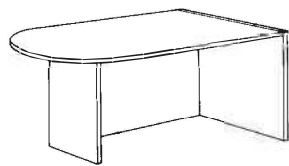

60x30x29	220	XMBD 6030R
66x30x29	235	XMBD 6630R
72x30x29	245	XMBD 7230R
72x36x29	265	XMBD 7236R

PMBD 6030R
PMBD 6630R
PMBD 7230R
PMBD 7236R

- Full modesty panel
- Accepts right hand return

BULLET RUNOFF DESKS

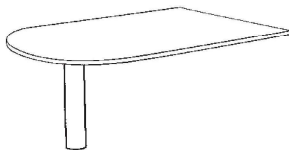

60x30x29	135	XBRO 6030
66x30x29	145	XBRO 6630
72x30x29	155	XBRO 7230

- Unhanded
- Not for freestanding applications
- Attaches to adjacent unit with heavy-duty metal flat plate
- 6" diameter black metal cylinder support
- XBRO may be used with both Express and ExpressPlus
- 12" diameter laminated cylinder support — LCS add \$

Denotes Quick Ship item. Available for Quick Ship in eight Quick Ship colors—see finishes.

OPTIONS

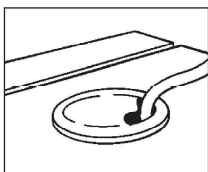

Grommet
FIGROM(x) — \$
indicate location

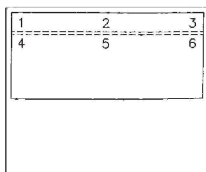

Grommet Locator

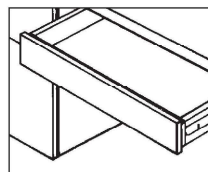

Pencil Drawer
PD — \$



12" Diameter laminated
Cylinder support
LCS — \$



Express



ExpressPlus

Size (WDH) Weight Model No. Price Model No. Price Features

CONFERENCE DESKS ("P"-DESKS)

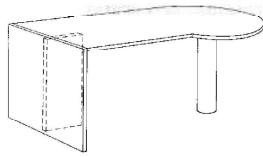

Indicated depth is overall depth — straight section of top is 6" narrower.

72x36x29	210	XOCD 7236A	POCD 7236A
84x36x29	225	XOCD 8436A	POCD 8436A
84x42x29	250	XOCD 8442A	POCD 8442A

- 6" diameter black metal cylinder support

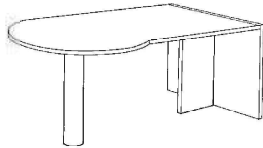

72x36x29	210	XOCD 7236B	POCD 7236B
84x36x29	225	XOCD 8436B	POCD 8436B
84x42x29	250	XOCD 8442B	POCD 8442B

- 6" diameter black metal cylinder support

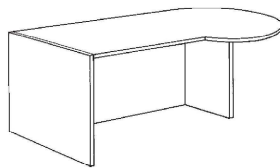

72x36x29	230	XMCD 7236LI	PMCD 7236LI
84x36x29	260	XMCD 8436LI	PMCD 8436LI
84x42x29	290	XMCD 8442LI	PMCD 8442LI

- Full modesty panel
- Accepts left hand return
- Conference round faces in

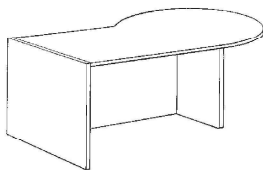

72x36x29	230	XMCD 7236LO	PMCD 7236LO
84x36x29	260	XMCD 8436LO	PMCD 8436LO
84x42x29	290	XMCD 8442LO	PMCD 8442LO

- Full modesty panel
- Accepts left hand return
- Conference round faces out

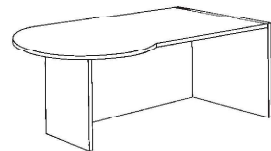

72x36x29	230	XMCD 7236RI	PMCD 7236RI
84x36x29	260	XMCD 8436RI	PMCD 8436RI
84x42x29	290	XMCD 8442RI	PMCD 8442RI

- Full modesty panel
- Accepts right hand return
- Conference round faces in

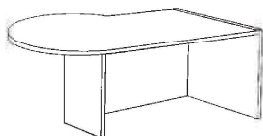

72x36x29	230	XMCD 7236RO	PMCD 7236RO
84x36x29	260	XMCD 8436RO	PMCD 8436RO
84x42x29	290	XMCD 8442RO	PMCD 8442RO

- Full modesty panel
- Accepts right hand return
- Conference round faces out

■ Denotes Quick Ship item. Available for Quick Ship in eight Quick Ship colors—see finishes.

OPTIONS

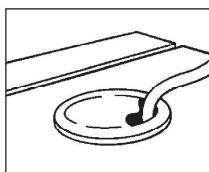

Grommet
FIGROM(x) — \$
indicate location

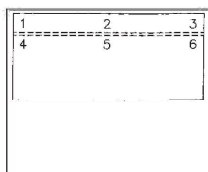

Grommet Locator

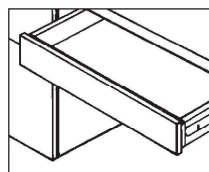

Pencil Drawer
PD — \$

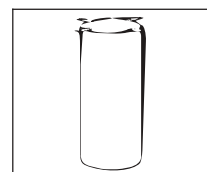

12" Diameter laminated
Cylinder support
LCS — \$



Express

ExpressPlus

Size (WDH) Weight Model No. Price Model No. Price Features

SINGLE PEDESTAL DESKS

48" w desks will not accept returns, 60" w desk will not accept 24" d returns.

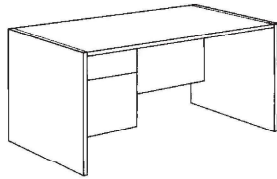

48x24x29	225	XSPD 4824L		PSPD 4824L	
48x30x29	250	XSPD 4830L		PSPD 4830L	
60x24x29	255	XSPD 6024L		PSPD 6024L	
60x30x29	275	XSPD 6030L		PSPD 6030L	
66x24x29	260	XSPD 6624L		PSPD 6624L	
66x30x29	280	XSPD 6630L		PSPD 6630L	
72x24x29	270	XSPD 7224L		PSPD 7224L	
72x30x29	295	XSPD 7230L		PSPD 7230L	
72x36x29	315	XSPD 7236L		PSPD 7236L	

- Left hand pedestal
- Accepts right hand return
- 1 box, 1 file drawer
- Drop lock included
- Modesty panel recessed 6", except 24" d has flush panel

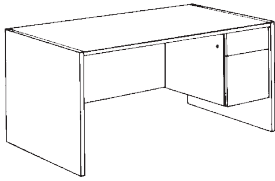

48x24x29	225	XSPD 4824R		PSPD 4824R	
48x30x29	250	XSPD 4830R		PSPD 4830R	
60x24x29	255	XSPD 6024R		PSPD 6024R	
60x30x29	275	XSPD 6030R		PSPD 6030R	
66x24x29	260	XSPD 6624R		PSPD 6624R	
66x30x29	280	XSPD 6630R		PSPD 6630R	
72x24x29	270	XSPD 7224R		PSPD 7224R	
72x30x29	295	XSPD 7230R		PSPD 7230R	
72x36x29	315	XSPD 7236R		PSPD 7236R	

- Right hand pedestal
- Accepts left hand return
- 1 box, 1 file drawer
- Drop lock included
- Modesty panel recessed 6", except 24" d has flush panel

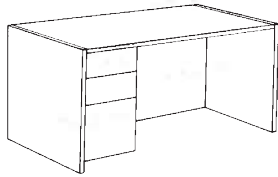

48x24x29	255	XCBF4824L		PCBF 4824L	
48x30x29	275	XCBF4830L		PCBF 4830L	
60x24x29	270	XCBF6024L		PCBF 6024L	
60x30x29	295	XCBF6030L		PCBF 6030L	
66x24x29	280	XCBF6624L		PCBF 6624L	
66x30x29	305	XCBF6630L		PCBF 6630L	
72x24x29	285	XCBF7224L		PCBF 7224L	
72x30x29	310	XCBF7230L		PCBF 7230L	
72x36x29	335	XCBF 7236L		PCBF 7236L	

- Left hand pedestal
- Accepts right hand return
- 2 box, 1 file drawer
- Drop lock included
- Full modesty panel recessed 6", except 24" d has flush panel

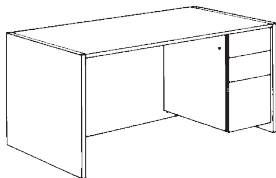

48x24x29	255	XCBF4824R		PCBF 4824R	
48x30x29	275	XCBF 4830R		PCBF 4830R	
60x24x29	270	XCBF 6024R		PCBF 6024R	
60x30x29	295	XCBF 6030R		PCBF 6030R	
66x24x29	280	XCBF 6624R		PCBF 6624R	
66x30x29	305	XCBF 6630R		PCBF 6630R	
72x24x29	285	XCBF 7224R		PCBF 7224R	
72x30x29	310	XCBF 7230R		PCBF 7230R	
72x36x29	335	XCBF 7236R		PCBF 7236R	

- Right hand pedestal
- Accepts left hand return
- 2 box, 1 file drawer
- Drop lock included
- Full modesty panel recessed 6", except 24" d has flush panel

Denotes Quick Ship item. Available for Quick Ship in eight Quick Ship colors—see finishes.

OPTIONS

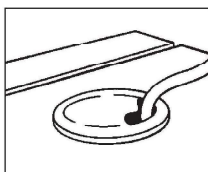

Grommet
FIGROM(x) — \$
indicate location

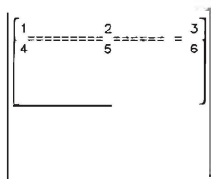

Grommet Locator

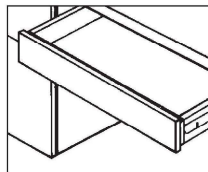

Pencil Drawer
PD — \$

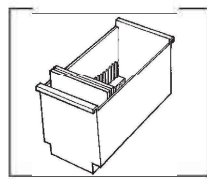

File Drawer Media Bin
holds 24 CD-ROM or
56 3½" Floppy Disks
MB — \$2

	Express			ExpressPlus			
	Size (WDH)	Weight	Model No.	Price	Model No.	Price	Features
SINGLE PEDESTAL DESKS							
	48x24x29	255	XCFF 4824L		PCFF 4824L		<ul style="list-style-type: none"> • Left hand pedestal • Accepts right hand return • 2 file drawers • Drop lock included • Full modesty panel recessed 6", except 24"d has flush panel
	48x30x29	275	XCFF 4830L		PCFF 4830L		
	60x24x29	270	XCFF 6030L		PCFF 6024L		
	60x30x29	295	XCFF 6624L		PCFF 6030L		
	66x24x29	280	XCFF 6630L		PCFF 6624L		
	66x30x29	305	XCFF 7224L		PCFF 6630L		
	72x24x29	285	XCFF 7230L		PCFF 7224L		
72x30x29	310	XCFF 7236L		PCFF 7230L			
72x36x29	335			PCFF 7236L			
	48x24x29	255	XCFF 4824R		PCFF 4824R		<ul style="list-style-type: none"> • Right hand pedestal • Accepts left hand return • 2 file drawers • Drop lock included • Full modesty panel recessed 6", except 24"d has flush panel
	48x30x29	275	XCFF 4830R		PCFF 4830R		
	60x24x29	270	XCFF 6024R		PCFF 6024R		
	60x30x29	295	XCFF 6030R		PCFF 6030R		
	66x24x29	280	XCFF 6624R		PCFF 6624R		
	66x30x29	305	XCFF 6630R		PCFF 6630R		
	72x24x29	285	XCFF 7224R		PCFF 7224R		
72x30x29	310	XCFF 7230R		PCFF 7230R			
72x36x29	335	XCFF 7236R		PCFF 7236R			
	48x24x29	145	XTDK 4824		PTDK 4824		<ul style="list-style-type: none"> • Open desk shell • 3/4" modesty panel recessed 6", except 24"d has flush panel
	48x30x29	165	XTDK 4830		PTDK 4830		
	60x24x29	160	XTDK 6024		PTDK 6024		
	60x30x29	180	XTDK 6030		PTDK 6030		
	66x24x29	175	XTDK 6624		PTDK 6624		
	66x30x29	195	XTDK 6630		PTDK 6630		
	72x24x29	180	XTDK 7224		PTDK 7224		
72x30x29	200	XTDK 7230		PTDK 7230			
72x36x29	225	XTDK 7236		PTDK 7236			
	48x24x29	165	XTDM 4824		PTDM 4824		<ul style="list-style-type: none"> • Open desk shell • Full modesty panel recessed 6", except 24"d has flush panel
	48x30x29	185	XTDM 4830		PTDM 4830		
	60x24x29	185	XTDM 6024		PTDM 6024		
	60x30x29	205	XTDM 6030		PTDM 6030		
	66x24x29	205	XTDM 6624		PTDM 6624		
	66x30x29	225	XTDM 6630		PTDM 6630		
	72x24x29	210	XTDM 7224		PTDM 7224		
72x30x29	230	XTDM 7230		PTDM 7230			
72x36x29	260	XTDM 7236		PTDM 7236			

Denotes Quick Ship item. Available for Quick Ship in eight Quick Ship colors—see finishes.

OPTIONS

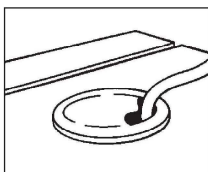

Grommet
FIGROM(x) — \$
indicate location

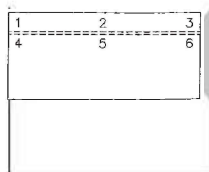

Grommet Locator

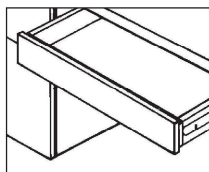

Pencil Drawer
PD — \$

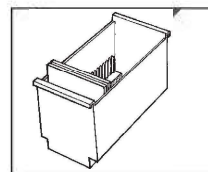

File Drawer Media Bin
holds 24 CD-ROM or
56 3 1/2" Floppy Disks
MB — \$



Express



ExpressPlus

Size (WDH) Weight Model No. Price Model No. Price Features

EXECUTIVE RETURNS

Worksurface height 29" AFF.

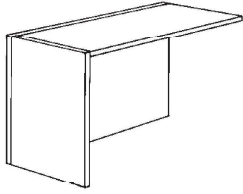

OPEN RETURNS—LEFT HAND

30x20x29	110	XOOE 3020L	POOE 3020L
36x20x29	115	XOOE 3620L	POOE3620L
42x20x29	135	XOOE 4220L	POOE 4220L
48x20x29	140	XOOE 4820L	POOE 4820L
60x20x29	165	XOOE 6020L	POOE 6020L
72x20x29	190	XOOE 7220L	POOE 7220L

30x24x29	120	XOOE 3024L	POOE 3024L
36x24x29	130	XOOE 3624L	POOE 3624L
42x24x29	145	XOOE 4224L	POOE 4224L
48x24x29	155	XOOE 4824L	POOE 4824L
60x24x29	180	XOOE 6024L	POOE 6024L
72x24x29	205	XOOE 7224L	POOE 7224L

36x30x29	160	XOOE 3630L	POOE 3630L
42x30x29	175	XOOE 4230L	POOE 4230L
48x30x29	195	XOOE 4830L	POOE 4830L
60x30x29	220	XOOE 6030L	POOE 6030L
72x30x29	245	XOOE 7230L	POOE 7230L

- 60" and 72" w units have 15" d support leg inset 36" from closed end
- One grommet included
- Use with extra deep corner extensions

OPEN RETURNS—RIGHT HAND

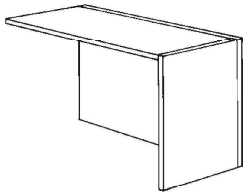

30x20x29	110	XOOE 3020R	POOE 3020R
36x20x29	115	XOOE 3620R	POOE 3620R
42x20x29	135	XOOE 4220R	POOE 4220R
48x20x29	140	XOOE 4820R	POOE 4820R
60x20x29	165	XOOE 6020R	POOE 6020R
72x20x29	190	XOOE 7220R	POOE 7220R

30x24x29	120	XOOE 3024R	POOE 3024R
36x24x29	130	XOOE 3624R	POOE 3624R
42x24x29	145	XOOE 4224R	POOE 4224R
48x24x29	155	XOOE 4824R	POOE 4824R
60x24x29	180	XOOE 6024R	POOE 6024R
72x24x29	205	XOOE 7224R	POOE 7224R

36x30x29	160	XOOE 3630R	POOE 3630R
42x30x29	175	XOOE 4230R	POOE 4230R
48x30x29	195	XOOE 4830R	POOE 4830R
60x30x29	220	XOOE 6030R	POOE 6030R
72x30x29	245	XOOE 7230R	POOE 7230R

- 60" and 72" w units have 15" d support leg inset 36" from closed end
- One grommet included
- Use with extra deep corner extensions

■ Denotes Quick Ship item. Available for Quick Ship in eight Quick Ship colors—see finishes.

Special Widths and Depths:

For in-between widths, specify letter code of desired model followed by SPECIAL (i.e., XOOE-SPECIAL) and indicate desired size — add 10% to price of next largest standard size. For in-between or custom depths, consult factory for availability, specification and pricing information.

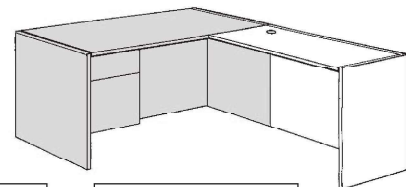

OPTIONS

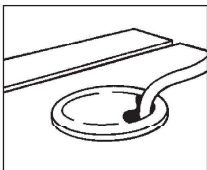

Grommet
FIGROM(x) — \$
indicate location

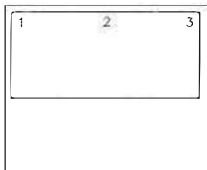

Grommet Locator

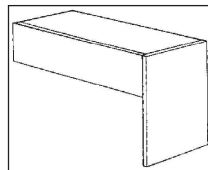

Short Back Panel — 8" h
8HI — \$

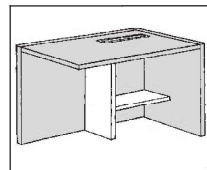

Printer Kit: 12" Side Panel,
24" x 12" Shelf, Paper Slot
P-KIT — \$

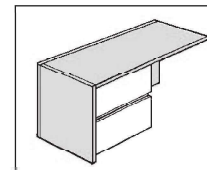

2 Drawer Lateral File,
30" w installed in
MOE LFO30 — \$

		Express		ExpressPlus		
Size (WDH)	Weight	Model No.	Price	Model No.	Price	Features

EXECUTIVE RETURNS

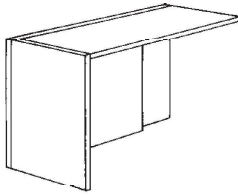

RETURNS WITH STATIONERY CABINET—LEFT HAND

36x20x29	165	XSOE 3620L		PSOE 3620L		• 4 adjustable shelves
42x20x29	185	XSOE 4220L		PSOE 4220L		
48x20x29	190	XSOE 4820L		PSOE 4820L		
60x20x29	215	XSOE 6020L		PSOE 6020L		
72x20x29	240	XSOE 7220L		PSOE 7220L		
<hr/>						
36x24x29	180	XSOE 3624L		PSOE 3624L		
42x24x29	195	XSOE 4224L		PSOE 4224L		
48x24x29	205	XSOE 4824L		PSOE 4824L		
60x24x29	230	XSOE 6024L		PSOE 6024L		
72x24x29	255	XSOE 7224L		PSOE 7224L		

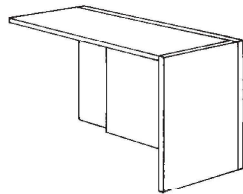

RETURNS WITH STATIONERY CABINET—RIGHT HAND

36x20x29	165	XSOE 3620R		PSOE 3620R		• 4 adjustable shelves
42x20x29	185	XSOE 4220R		PSOE 4220R		
48x20x29	190	XSOE 4820R		PSOE 4820R		
60x20x29	215	XSOE 6020R		PSOE 6020R		
72x20x29	240	XSOE 7220R		PSOE 7220R		
<hr/>						
36x24x29	180	XSOE 3624R		PSOE 3624R		
42x24x29	195	XSOE 4224R		PSOE 4224R		
48x24x29	205	XSOE 4824R		PSOE 4824R		
60x24x29	230	XSOE 6024R		PSOE 6024R		
72x24x29	255	XSOE 7224R		PSOE 7224R		

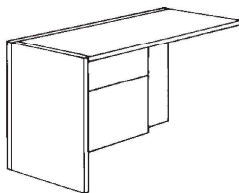

RETURNS WITH BOX, FILE PEDESTALS—LEFT HAND

36x20x29	175	XFOE 3620L		PFOE 3620L	
42x20x29	195	XFOE 4220L		PFOE 4220L	
48x20x29	200	XFOE 4820L		PFOE 4820L	
60x20x29	225	XFOE 6020L		PFOE 6020L	
72x20x29	250	XFOE 7220L		PFOE 7220L	
<hr/>					
36x24x29	200	XFOE 3624L		PFOE 3624L	
42x24x29	215	XFOE 4224L		PFOE 4224L	
48x24x29	225	XFOE 4824L		PFOE 4824L	
60x24x29	250	XFOE 6024L		PFOE 6024L	
72x24x29	275	XFOE 7224L		PFOE 7224L	

Option: Box/box/box pedestal — add \$ to box/file price, specify XFOE-3B or PFOE-3B

Denotes Quick Ship item. Available for Quick Ship in eight Quick Ship colors—see finishes.

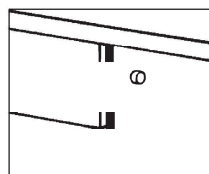

Pedestal Lock
D-LOCK — \$

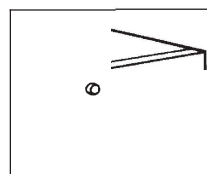

Door Lock
C-LOCK — \$

Special Widths and Depths:

For in-between widths, specify letter code of desired model followed by **SPECIAL** (i.e., XOO-SPECIAL) and indicated desired size — add 10% to price of next largest standard size. For in-between or custom depths, consult factory for availability, specification and pricing information.

OPTIONS

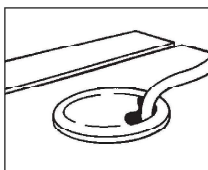

Grommet
FIGROM(x) — \$
indicate location



Grommet Locator

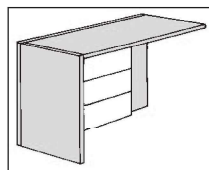

Box/box/box Pedestal
specify XFOE-3B or
PFOE-3B — add \$

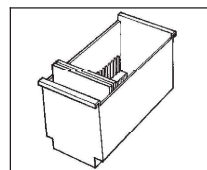

File Drawer Media Bin
holds 24 CD-ROM or
56 3½" Floppy Disks
MB — \$

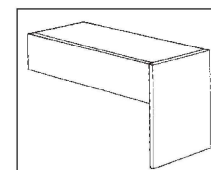

Short Back Panel —
8" h 8HI — add \$



Express

ExpressPlus

Size (WDH) Weight

Model No. Price

Model No. Price

EXECUTIVE RETURNS

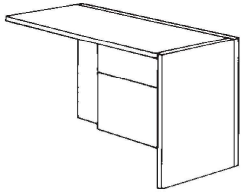

RETURNS WITH BOX, FILE PEDESTALS—RIGHT HAND

36x20x29	175	XFOE 3620R	PFOE 3620R
42x20x29	195	XFOE 4220R	PFOE 4220R
48x20x29	200	XFOE 4820R	PFOE 4820R
60x20x29	225	XFOE 6020R	PFOE 6020R
72x20x29	250	XFOE 7220R	PFOE 7220R

36x24x29	200	XFOE 3624R	PFOE 3624R
42x24x29	215	XFOE 4224R	PFOE 4224R
48x24x29	225	XFOE 4824R	PFOE 4824R
60x24x29	250	XFOE 6024R	PFOE 6024R
72x24x29	275	XFOE 7224R	PFOE 7224R

OPTION: Box/box/box pedestal — add \$ to box/file price, specify XFOE-3B or PFOE-3B

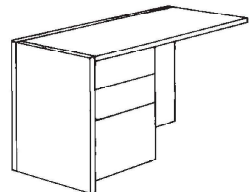

RETURNS WITH BOX/BOX/FILE PEDESTAL—LEFT HAND

36x20x29	200	XBBE 3620L	PBBE 3620L
42x20x29	220	XBBE 4220L	PBBE 4220L
48x20x29	225	XBBE 4820L	PBBE 4820L
60x20x29	250	XBBE 6020L	PBBE 6020L
72x20x29	275	XBBE 7220L	PBBE 7220L

36x24x29	225	XBBE 3624L	PBBE 3624L
42x24x29	240	XBBE 4224L	PBBE 4224L
48x24x29	250	XBBE 4824L	PBBE 4824L
60x24x29	275	XBBE 6024L	PBBE 6024L
72x24x29	300	XBBE 7224L	PBBE 7224L

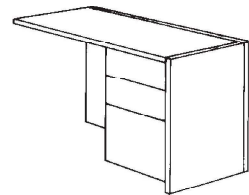

RETURNS WITH BOX/BOX/FILE PEDESTAL—RIGHT HAND

36x20x29	200	XBBE 3620R	PBBE 3620R
42x20x29	220	XBBE 4220R	PBBE 4220R
48x20x29	225	XBBE 4820R	PBBE 4820R
60x20x29	250	XBBE 6020R	PBBE 6020R
72x20x29	275	XBBE 7220R	PBBE 7220R

36x24x29	225	XBBE 3624R	PBBE 3624R
42x24x29	240	XBBE 4224R	PBBE 4224R
48x24x29	250	XBBE 4824R	PBBE 4824R
60x24x29	275	XBBE 6024R	PBBE 6024R
72x24x29	300	XBBE 7224R	PBBE 7224R

OPTION: File/file pedestal — use Box/box/file price, specify XBBE-FF or PBBE-FF

Denotes Quick Ship item. Available for Quick Ship in eight Quick Ship colors—see finishes.

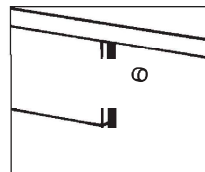

Pedestal Lock
D-LOCK — \$

Special Widths and Depths:
For in-between widths, specify letter code of desired model followed by SPECIAL (i.e., XOOO-SPECIAL) and indicated desired size — add 10% to price of next largest standard size. For in-between or custom depths, consult factory for availability, specification and pricing information.

OPTIONS

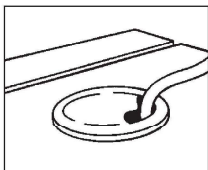

Grommet
FIGROM(x) — \$
indicate location

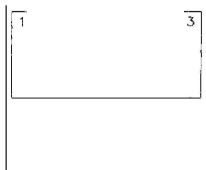

Grommet Locator

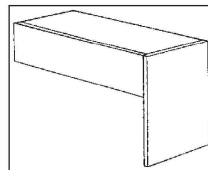

Short Back Panel
— 8" h 8HI — \$

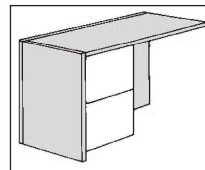

File/file Pedestal
specify XBBE-FF or
PBBE-FF — add \$

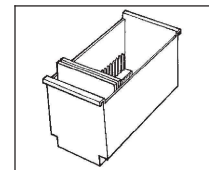

File Drawer Media Bin
holds 24 CD-ROM or
56 3½" Floppy Disks
MB — \$

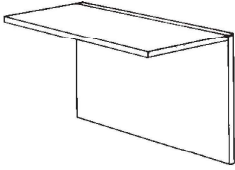
			Express	ExpressPlus	
	Size (WDH)	Weight	Model No.	Price	Model No. Price Features
EXECUTIVE RETURNS					
	OPEN BRIDGE RETURNS (UNHANDED)				
	36x20x29	95	XBRE 3620		PBRE 3620
	42x20x29	110	XBRE 4220		PBRE 4220
	48x20x29	120	XBRE 4820		PBRE 4820
	54x20x29	135	XBRE 5420		PBRE 5420
	60x20x29	145	XBRE 6020		PBRE 6020
	72x20x29	165	XBRE 7220		PBRE 7220
	36x24x29	105	XBRE 3624		PBRE 3624
	42x24x29	120	XBRE 4224		PBRE 4224
	48x24x29	135	XBRE 4824		PBRE 4824
	54x24x29	150	XBRE 5424		PBRE 5424
	60x24x29	160	XBRE 6024		PBRE 6024
	72x24x29	175	XBRE 7224		PBRE 7224

• Units 60" or wider have 12"d support panel centered on width

• Units 60" or wider have 12"d support panel centered on width

Denotes Quick Ship item. Available for Quick Ship in eight Quick Ship colors—see finishes.

EXPRESS / EXPRESSPLUS

OPTIONS

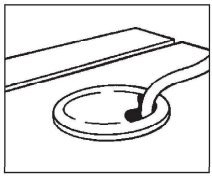

Grommet
FIGROM(x) — \$
indicate location

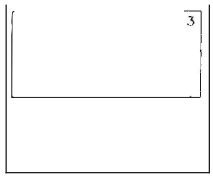

Grommet Locator

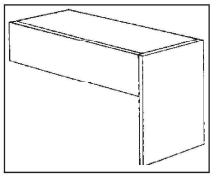

Short Back Panel —
8"h 8HI — \$



Express

ExpressPlus

Size (WDH) Weight Model No. Price

Model No. Price

EXECUTIVE RETURNS

EXECUTIVE HEIGHT CORNER EXTENSIONS

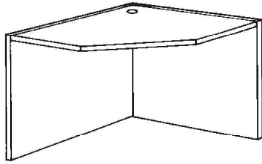

Note: Open extensions are not freestanding. They may be used between two other components or they may be attached to a single other component if a panel end is added to the open end. A panel end will add 1¼" to the size of the unit. Support panels should be added where corner extensions abut open or bridge returns or pedestal returns wider than 48".

36x36x29	160	XCRE 3636	PCRE 3636	• <i>Corner grommet is standard</i>
36x42x29	180	XCRE 3642A	PCRE 3642A	
42x36x29	180	XCRE 4236B	PCRE 4236B	
36x42x29	180	XCRE 3642C	PCRE 3642C	
42x36x29	180	XCRE 4236D	PCRE 4236D	
42x42x29	195	XCRE 4242	PCRE 4242	
48x48x29	235	XCRE 4848E	PCRE 4848E	

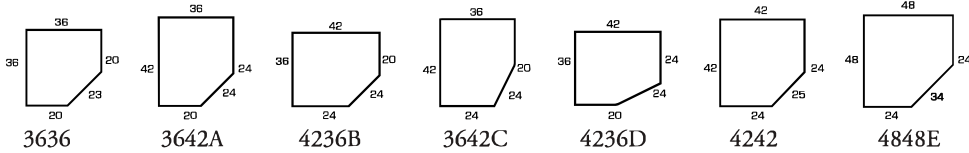

EXTRA DEEP CORNER EXTENSIONS

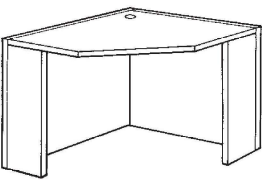

48x42x29		XCRE 4842A	PCRE 4842A	• <i>Corner grommet is standard</i> • <i>12" d support panel on 24" d ends</i> • <i>15" d support panel on 30" d ends</i>
42x48x29		XCRE 4248B	PCRE 4248B	
48x42x29		XCRE 4842C	PCRE 4842C	
42x48x29		XCRE 4248D	PCRE 4248D	
48x48x29		XCRE 4848G	PCRE 4848G	

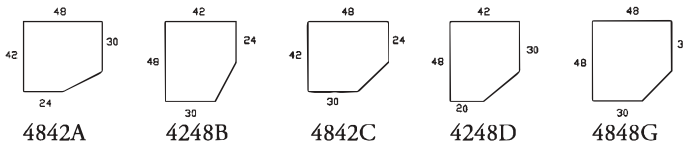

LEGS

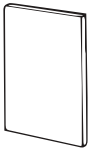

20x1¼x29		XLEG 2029	PLEG 2029
24x1¼x29		XLEG 2429	PLEG 2429
30x1¼x29		XLEG 3029	PLEG 3029
36x1¼x29		XLEG 3629	PLEG 3629

SUPPORT PANELS



12x1¼x27¾	15	XSP 1227
15x1¼x27¾	20	XSP 1527



Denotes Quick Ship item. Available for Quick Ship in eight Quick Ship colors—see finishes.

OPTIONS

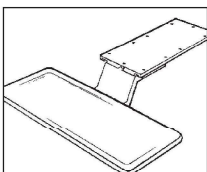

Slide-out Keyboard with Center Mount Slide and Molded Tray ZOK — \$

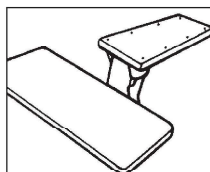

Articulating Keyboard with Molded Tray ART-M — \$

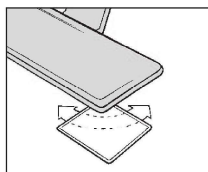

Mouse Pad Extension mounts to ZOK or ART-M MPE — \$

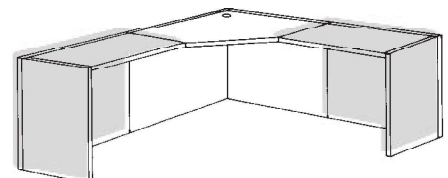



Express



ExpressPlus

Size (WDH) Weight Model No. Price

Model No. Price

SECRETARIAL RETURNS

Worksurface height 26" AFF, 3" h gallery rail.

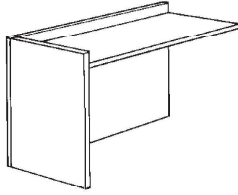

OPEN RETURNS—LEFT HAND

30x20x29	110	XOOS3020L	POOS 3020L
36x20x29	115	XOOS3620L	POOS 3620L
42x20x29	135	XOOS4220L	POOS 4220L
48x20x29	140	XOOS4820L	POOS 4820L
60x20x29	165	XOOS6020L	POOS 6020L
72x20x29	190	XOOS 7220L	POOS 7220L

30x24x29	120	XOOS 3024L	POOS 3024L
36x24x29	130	XOOS 3624L	POOS 3624L
42x24x29	145	XOOS 4224L	POOS 4224L
48x24x29	155	XOOS 4824L	POOS 4824L
60x24x29	180	XOOS 6024L	POOS 6024L
72x24x29	205	XOOS 7224L	POOS 7224L

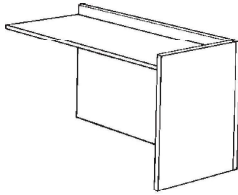

OPEN RETURNS—RIGHT HAND

30x20x29	110	XOOS3020R	POOS3020R
36x20x29	115	XOOS3620R	POOS3620R
42x20x29	135	XOOS4220R	POOS4220R
48x20x29	140	XOOS4820R	POOS4820R
60x20x29	165	XOOS6020R	POOS6020R
72x20x29	190	XOOS 7220R	POOS 7220R

30x24x29	120	XOOS 3024R	POOS 3024R
36x24x29	130	XOOS 3624R	POOS 3624R
42x24x29	145	XOOS 4224R	POOS 4224R
48x24x29	155	XOOS 4824R	POOS 4824R
60x24x29	180	XOOS 6024R	POOS 6024R
72x24x29	205	XOOS 7224R	POOS 7224R

Denotes Quick Ship item. Available for Quick Ship in eight Quick Ship colors—see finishes.

EXPRESS / EXPRESSPLUS

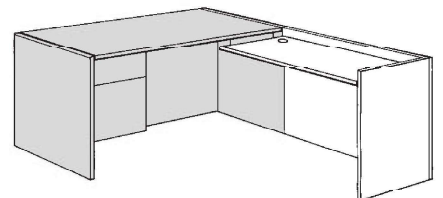

OPTIONS

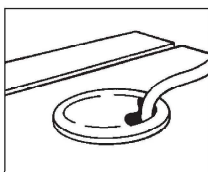

Grommet
FIGROM(x) — \$
indicate location



Grommet Locator

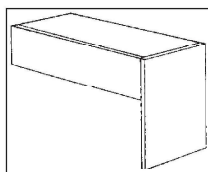

Short Back Panel —
8" h 8HI — \$

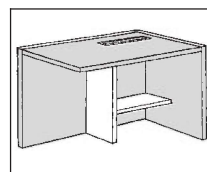

Printer Kit: 12" Side Panel,
24"x12" Shelf, Paper Slot
P-KIT — \$

Special Widths and Depths:

For in-between widths, specify letter code of desired model followed by SPECIAL (i.e., XOOS-SPECIAL) and indicated desired size — add 10% to price of next largest standard size. For in-between or custom depths, consult factory for availability, specification and pricing information.

			Express						ExpressPlus
	Size (WDH)	Weight	Model No.	Price		Model No.	Price		Features

SECRETARIAL RETURNS

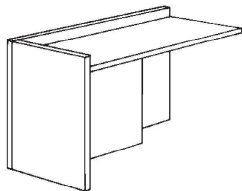

RETURNS WITH STATIONERY CABINET—LEFT HAND

36x20x29	165	XSOS 3620L	XSOS 3620L	PSOS 3620L	• 4 adjustable shelves
42x20x29	185	XSOS 4220L	XSOS 4220L	PSOS 4220L	
48x20x29	190	XSOS 4820L	XSOS 4820L	PSOS 4820L	
60x20x29	215	XSOS 6020L	XSOS 6020L	PSOS 6020L	
72x20x29	240	XSOS 7220L	XSOS 7220L	PSOS 7220L	
36x24x29	180	XSOS 3624L	XSOS 3624L	PSOS 3624L	
42x24x29	195	XSOS 4224L	XSOS 4224L	PSOS 4224L	
48x24x29	205	XSOS 4824L	XSOS 4824L	PSOS 4824L	
60x24x29	230	XSOS 6024L	XSOS 6024L	PSOS 6024L	
72x24x29	255	XSOS 7224L	XSOS 7224L	PSOS 7224L	

RETURNS WITH STATIONERY CABINET—RIGHT HAND

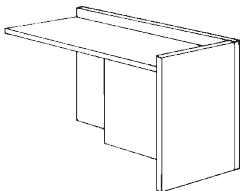

36x20x29	165	XSOS 3620R	XSOS 3620R	PSOS 3620R	• 4 adjustable shelves
42x20x29	185	XSOS 4220R	XSOS 4220R	PSOS 4220R	
48x20x29	190	XSOS 4820R	XSOS 4820R	PSOS 4820R	
60x20x29	215	XSOS 6020R	XSOS 6020R	PSOS 6020R	
72x20x29	240	XSOS 7220R	XSOS 7220R	PSOS 7220R	
36x24x29	180	XSOS 3624R	XSOS 3624R	PSOS 3624R	
42x24x29	195	XSOS 4224R	XSOS 4224R	PSOS 4224R	
48x24x29	205	XSOS 4824R	XSOS 4824R	PSOS 4824R	
60x24x29	230	XSOS 6024R	XSOS 6024R	PSOS 6024R	
72x24x29	255	XSOS 7224R	XSOS 7224R	PSOS 7224R	

RETURNS WITH BOX, FILE PEDESTALS—LEFT HAND

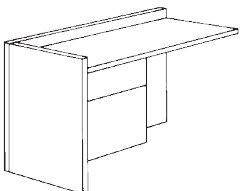

36x20x29	175	XFOS 3620L	XFOS 3620L	PFOS 3620L
42x20x29	195	XFOS 4220L	XFOS 4220L	PFOS 4220L
48x20x29	200	XFOS 4820L	XFOS 4820L	PFOS 4820L
60x20x29	225	XFOS 6020L	XFOS 6020L	PFOS 6020L
72x20x29	250	XFOS 7220L	XFOS 7220L	PFOS 7220L
36x24x29	200	XFOS 3624L	XFOS 3624L	PFOS 3624L
42x24x29	215	XFOS 4224L	XFOS 4224L	PFOS 4224L
48x24x29	225	XFOS 4824L	XFOS 4824L	PFOS 4824L
60x24x29	250	XFOS 6024L	XFOS 6024L	PFOS 6024L
72x24x29	275	XFOS 7224L	XFOS 7224L	PFOS 7224L

Denotes Quick Ship item. Available for Quick Ship in eight Quick Ship colors—see finishes.

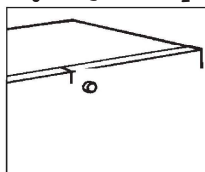

Door Lock
C-LOCK — \$

Special Widths and Depths:
For in-between widths, specify letter code of desired model followed by SPECIAL (i.e., X00S-SPECIAL) and indicated desired size — add 10% to price of next largest standard size. For in-between or custom depths, consult factory for availability, specification and pricing information.

OPTIONS

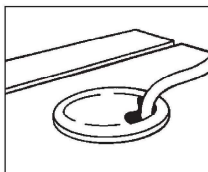

Grommet
FIGROM(x) — \$
indicate location



Grommet Locator

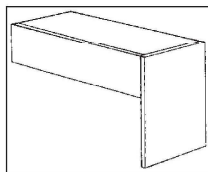

Short Back Panel —
8" h 8HI — \$

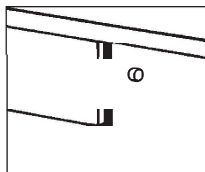

Pedestal Lock
D-LOCK — \$

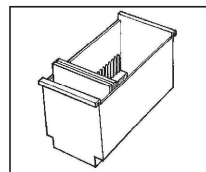

File Drawer Media Bin
holds 24 CD-ROM or
56 3½" Floppy Disks
MB — \$

			Express	ExpressPlus
	Size (WDH)	Weight	Model No. Price	Model No. Price

SECRETARIAL RETURNS

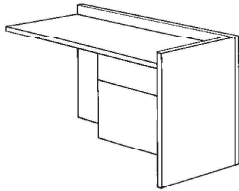

RETURNS WITH BOX, FILE PEDESTALS—RIGHT HAND

36x20x29	175	XFOS 3620R	PFOS 3620R
42x20x29	195	FOS 4220R	PFOS 4220R
48x20x29	200	XFOS 4820R	PFOS 4820R
60x20x29	225	XFOS 6020R	PFOS 6020R
72x20x29	250	XFOS 7220R	PFOS 7220R

36x24x29	200	XFOS 3624R	PFOS 3624R
42x24x29	215	XFOS 4224R	PFOS 4224R
48x24x29	225	XFOS 4824R	PFOS 4824R
60x24x29	250	XFOS 6024R	PFOS 6024R
72x24x29	275	XFOS 7224R	PFOS 7224R

RETURNS WITH 3 BOX DRAWERS—LEFT HAND

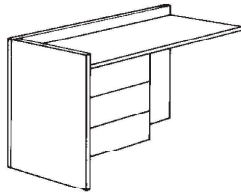

36x20x29	175	XBOS 3620L	PBOS 3620L
42x20x29	195	XBOS 4220L	PBOS 4220L
48x20x29	200	XBOS 4820L	PBOS 4820L
60x20x29	225	XBOS 6020L	PBOS 6020L
72x20x29	250	XBOS 7220L	PBOS 7220L

36x24x29	200	XBOS 3624L	PBOS 3624L
42x24x29	215	XBOS 4224L	PBOS 4224L
48x24x29	225	XBOS 4824L	PBOS 4824L
60x24x29	250	XBOS 6024L	PBOS 6024L
72x24x29	275	XBOS 7224L	PBOS 7224L

RETURNS WITH 3 BOX DRAWERS—RIGHT HAND

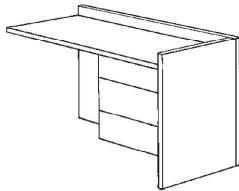

36x20x29	175	XBOS 3620R	PBOS 3620R
42x20x29	195	XBOS 4220R	PBOS 4220R
48x20x29	200	XBOS 4820R	PBOS 4820R
60x20x29	225	XBOS 6020R	PBOS 6020R
72x20x29	250	XBOS 7220R	PBOS 7220R

36x24x29	200	XBOS 3624R	PBOS 3624R
42x24x29	215	XBOS 4224R	PBOS 4224R
48x24x29	225	XBOS 4824R	PBOS 4824R
60x24x29	250	XBOS 6024R	PBOS 6024R
72x24x29	275	XBOS 7224R	PBOS 7224R

Denotes Quick Ship item. Available for Quick Ship in eight Quick Ship colors—see finishes.

Special Widths and Depths:

For in-between widths, specify letter code of desired model followed by SPECIAL (i.e., XOOS-SPECIAL) and indicated desired size — add 10% to price of next largest standard size. For in-between or custom depths, consult factory for availability, specification and pricing information.

OPTIONS

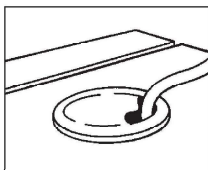

Grommet
FIGROM(x) — \$
indicate location



Grommet Locator

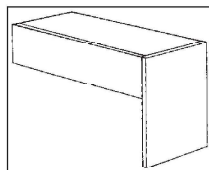

Short Back Panel —
8" h 8HI — \$2

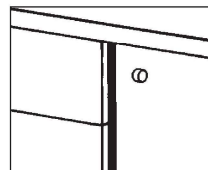

Pedestal Lock
D-LOCK — \$

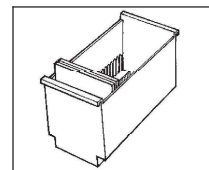

File Drawer Media Bin
holds 24 CD-ROM or
56 3½" Floppy Disks
MB — \$



Express

ExpressPlus

Size (WDH) Weight Model No. Price Model No. Price Features

SECRETARIAL RETURNS

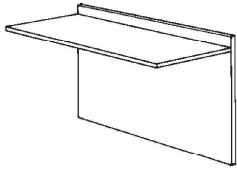

OPEN BRIDGE RETURNS (UNHANDED)

Size (WDH)	Weight	Model No.	Price	Model No.	Price	Features
36x20x29	95	XBRS 3620		PBRS 3620		• Units 60" or wider have 12"d support panel centered on width
42x20x29	110	XBRS 4220		PBRS 4220		
48x20x29	120	XBRS 4820		PBRS 4820		
54x20x29	135	XBRS 5420		PBRS 5420		
60x20x29	145	XBRS 6020		PBRS 6020		
72x20x29	165	XBRS 7220		PBRS 7220		
36x24x29	105	XBRS 3624		PBRS 3624		• Units 60" or wider have 12"d support panel centered on width
42x24x29	120	XBRS 4224		PBRS 4224		
48x24x29	135	XBRS 4824		PBRS 4824		
54x24x29	150	XBRS 5424		PBRS 5424		
60x24x29	160	XBRS 6024		PBRS 6024		
72x24x29	175	XBRS 7224		PBRS 7224		

Denotes Quick Ship item. Available for Quick Ship in eight Quick Ship colors—see finishes.

EXPRESS/EXPRESSPLUS

OPTIONS

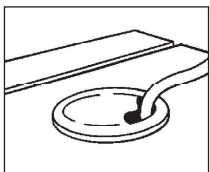

Grommet
FIGROM(x) — \$
indicate location

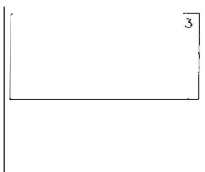

Grommet Locator

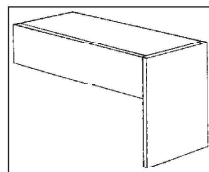

Short Back Panel —
8"h 8HI — \$

Special Widths and Depths:
For in-between widths, specify letter code of desired model followed by SPECIAL (i.e., XOOS-SPECIAL) and indicated desired size — add 10% to price of next largest standard size. For in-between or custom depths, consult factory for availability, specification and pricing information.

	Express		ExpressPlus		
Size (WDH)	Weight	Model No.	Price	Model No.	Price Features

SECRETARIAL RETURNS

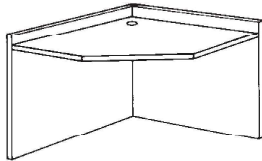

SECRETARIAL HEIGHT CORNER EXTENSIONS

Note: Open extensions are not freestanding. They may be used between two other components or they may be attached to a single other component if a panel end is added to the open end. A panel end will add 1¼" to the size of the unit. Support panels should be added where corner extensions abut open or bridge returns or pedestal returns wider than 48".

36x36x29	160	XCRS 3636	■	PCRS 3636	• Corner grommet is standard
36x42x29	180	XCRS 3642A		PCRS 3642A	
42x36x29	180	XCRS 4236B		PCRS 4236B	
36x42x29	180	XCRS 3642C		PCRS 3642C	
42x36x29	180	XCRS 4236D		PCRS 4236D	
42x42x29	195	XCRS 4242		PCRS 4242	
48x48x29	235	XCRS 4848		PCRS 4848	

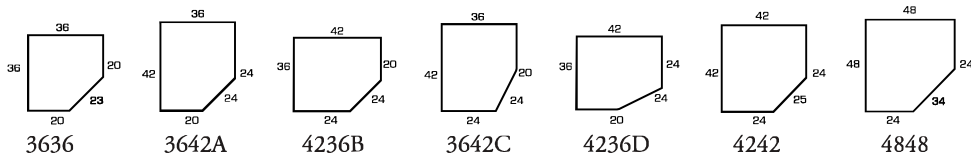

LEGS



20x1¼x29	35	XLEG 2029	PLEG 2029
24x1¼x29	40	XLEG 2429	PLEG 2429
30x1¼x29	45	XLEG 3029	PLEG 3029
36x1¼x29	50	XLEG 3629	PLEG 3629

SUPPORT PANELS



12x1¼x24¾	15	XSP 1224
15x1¼x24¾	20	XSP 1524

Denotes Quick Ship item. Available for Quick Ship in eight Quick Ship colors—see finishes.

OPTIONS

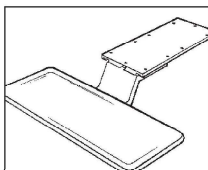

Slide-Out Keyboard with Center Mount Slide and Molded Tray ZOK — \$

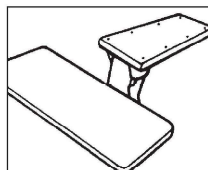

Articulating Keyboard with Molded Tray ART-M — \$

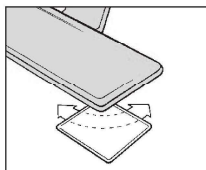

Mouse Pad Extension mounts to ZOK or ART-M MPE — \$

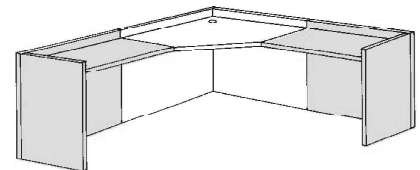



Express

ExpressPlus

Size (WDH) Weight Model No. Price Model No. Price Features

COMPUTER TABLE / MACHINE STANDS

May be used alone or customized with options to meet specific applications (ex: add printer slot and paper shelf to make a printer stand, add casters and slide-out keyboard tray for mobile terminal table, etc.).

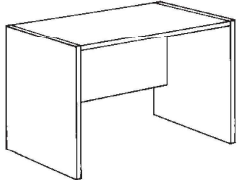

MACHINE HEIGHT UNITS

24x24x26	120	XSCT 2424	PSCT 2424	• 3/4 modesty panel inset 1/2" from back
30x24x26	130	XSCT 3024	PSCT 3024	
36x24x26	140	XSCT 3624	PSCT 3624	
42x24x26	150	XSCT 4224	PSCT 4224	
48x24x26	160	XSCT 4824	PSCT 4824	
60x24x26	180	XSCT 6024	PSCT 6024	
72x24x26	195	XSCT 7224	PSCT 7224	

24x30x26	140	XSCT 2430	PSCT 2430	• 3/4 modesty panel inset 6" from back
30x30x26	150	XSCT 3030	PSCT 3030	
36x30x26	160	XSCT 3630	PSCT 3630	
42x30x26	175	XSCT 4230	PSCT 4230	
48x30x26	185	XSCT 4830	PSCT 4830	
60x30x26	210	XSCT 6030	PSCT 6030	
72x30x26	235	XSCT 7230	PSCT 7230	

DESK HEIGHT UNITS

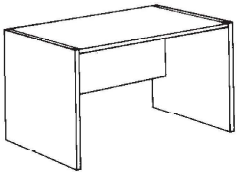

24x24x29	125	XSCE 2424	PSCE 2424	• 3/4 modesty panel inset 1/2" from back
30x24x29	135	XSCE 3024	PSCE 3024	
36x24x29	145	XSCE 3624	PSCE 3624	
42x24x29	155	XSCE 4224	PSCE 4224	
48x24x29	165	XSCE 4824	PSCE 4824	
60x24x29	185	XSCE 6024	PSCE 6024	
72x24x29	200	XSCE 7224	PSCE 7224	

24x30x29	145	XSCE 2430	PSCE 2430	• 3/4 modesty panel inset 6" from back
30x30x29	155	XSCE 3030	PSCE 3030	
36x30x29	165	XSCE 3630	PSCE 3630	
42x30x29	180	XSCE 4230	PSCE 4230	
48x30x29	190	XSCE 4830	PSCE 4830	
60x30x29	215	XSCE 6030	PSCE 6030	
72x30x29	240	XSCE 7230	PSCE 7230	

Denotes Quick Ship item. Available for Quick Ship in eight Quick Ship colors—see finishes.

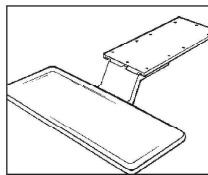

Slide-out Keyboard with Center Mount Slide and Molded Tray ZOK — \$

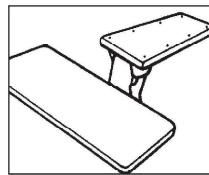

Articulating Keyboard with Molded Tray ART-M — \$

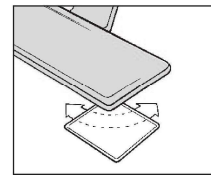

Mouse Pad Extension mounts to ZOK or ART-M MPE — \$

OPTIONS

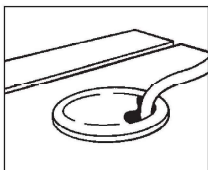

Grommet FIGROM(x) — \$ indicate location

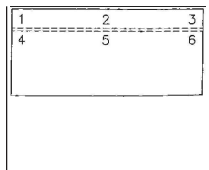

Grommet Locator

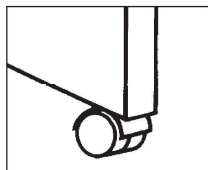

Casters (4) CAST — \$

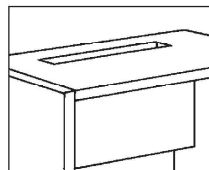

Printer Slot P-Slot — \$

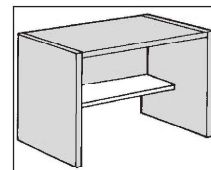

Paper Shelf — 12" d up to 36" w PSU36 — \$ over 36" w PSO36 — \$

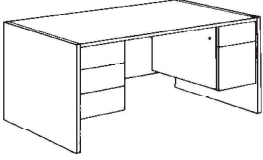
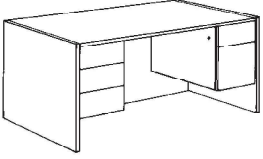
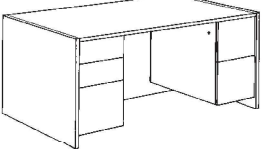
	Express			ExpressPlus			
	Size (WDH)	Weight	Model No.	Price	Model No.	Price	Features
DOUBLE PEDESTAL DESKS							
	60x24x29	320	XDPD 6024		PDPD 6024		<ul style="list-style-type: none"> • 3/4" modesty panel recessed 6", except 24" d has flush modesty • Drop lock on boxfile pedestal • 3 box left, boxfile right
	60x30x29	330	XDPD 6030		PDPD 6030		
	66x24x29	330	XDPD 6624		PDPD 6624		
	66x30x29	350	XDPD 6630		PDPD 6630		
	72x24x29	335	XDPD 7224		PDPD 7224		
	72x30x29	355	XDPD 7230		PDPD 7230		
	72x36x29	380	XDPD 7236		PDPD 7236		
	60x24x29	345	XDMD 6024		PDMD 6024		<ul style="list-style-type: none"> • Full modesty panel recessed 6", except 24" d has flush modesty • Drop lock on boxfile pedestal • 3 box left, boxfile right
	60x30x29	355	XDMD 6030		PDMD 6030		
	66x24x29	355	XDMD 6624		PDMD 6624		
	66x30x29	375	XDMD 6630		PDMD 6630		
	72x24x29	365	XDMD 7224		PDMD 7224		
	72x30x29	385	XDMD 7230		PDMD 7230		
	72x36x29	410	XDMD 7236		PDMD 7236		
	60x24x29	345	XCPD 6024		PCPD 6024		<ul style="list-style-type: none"> • Full modesty panel recessed 6", except 24" d has flush modesty • Drop lock on filefile pedestal • Box/boxfile left, filefile right
	60x30x29	365	XCPD 6030		PCPD 6030		
	66x24x29	355	XCPD 6624		PCPD 6624		
	66x30x29	375	XCPD 6630		PCPD 6630		
	72x24x29	365	XCPD 7224		PCPD 7224		
	72x30x29	390	XCPD 7230		PCPD 7230		
	72x36x29	415	XCPD 7236		PCPD 7236		

Denotes Quick Ship item. Available for Quick Ship in eight Quick Ship colors—see finishes.

EXPRESS/EXPRESSPLUS

OPTIONS

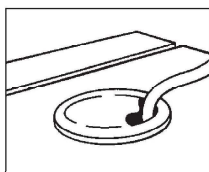

Grommet
FIGROM(x) — \$
indicate location

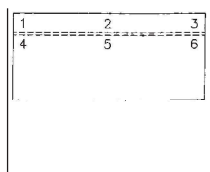

Grommet Locator

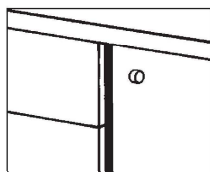

Pedestal Lock
D-LOCK — \$

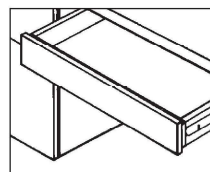

Pencil Drawer
PD — \$

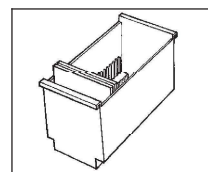

File Drawer Media Bin
holds 24 CD-ROM or
56 3 1/2" Floppy Disks
MB — \$

Size (WDH)	Weight	Express		Express Plus		Features
		Model No.	Price	Model No.	Price	

C R E D E N Z A S

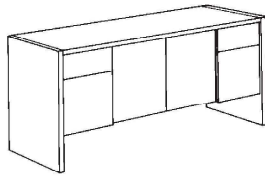

STORAGE CREDENZA

60x20x29	295	XDCC 6020		PDCC 6020	
72x20x29	310	XDCC 7220		PDCC 7220	
84x20x29	340	XDCC 8420		PDCC 8420	

- 2 box, 2 file drawers
- Two door cabinet with adjustable shelf
- Lock on right hand pedestal

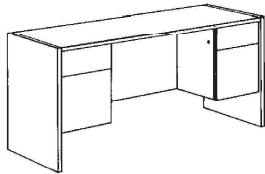

DOUBLE PEDESTAL CREDENZA

60x20x29	290	XDOC 6020		PDOC 6020	
72x20x29	300	XDOC 7220		PDOC 7220	
84x20x29	310	XDOC 8420		PDOC 8420	

- 2 box, 2 file drawers
- Lock on right hand pedestal
- ¾ modesty panel

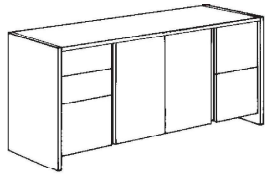

CUBE STYLE CREDENZA

60x20x29	335	XDSC 6020		PDSC 6020	
72x20x29	365	XDSC 7220		PDSC 7220	
84x20x29	395	XDSC 8420		PDSC 8420	

- Box/boxfile left, file/file right
- Two door cabinet with adjustable shelf
- Lock on right hand pedestal

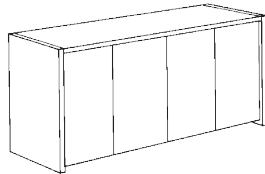

FOUR DOOR CREDENZA

60x20x29	295	X4DC 6020		P4DC 6020	
72x20x29	320	X4DC 7220		P4DC 7220	
84x20x29	350	X4DC 8420		P4DC 8420	

- Two interior sections
- One adjustable shelf per section

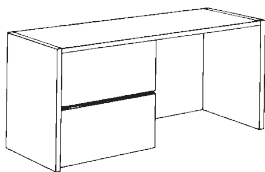

LATERAL FILE CREDENZA

60x20x29	345	XLOC 6020L		PLOC 6020L	
72x20x29	370	XLOC 7220L		PLOC 7220L	
84x20x29	395	XLOC 8420L		PLOC 8420L	

- Two 30" w lateral file drawers with lock
- 36" w laterals add \$100
- Full modesty panel

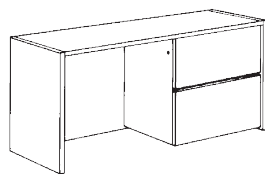

60x20x29	345	XLOC 6020R		PLOC 6020R	
72x20x29	370	XLOC 7220R		PLOC 7220R	
84x20x29	395	XLOC 8420R		PLOC 8420R	

- Two 30" w lateral file drawers with lock
- 36" w laterals add \$
- Full modesty panel

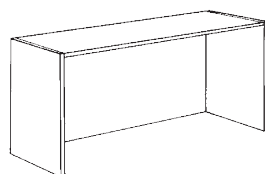

OPEN CREDENZA

60x20x29	200	XOOC 6020		POOC 6020	
72x20x29	220	XOOC 7220		POOC 7220	
84x20x29	240	XOOC 8420		POOC 8420	

- Full modesty panel
- Add 18" d universal pedestals from page 54 to create custom single or double pedestal credenzas

OPTIONS

Denotes Quick Ship item. Available for Quick Ship in eight Quick Ship colors—see finishes.

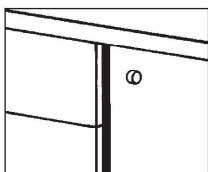

Pedestal Lock
D-LOCK — \$

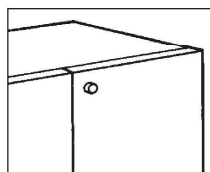

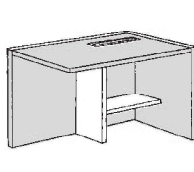

Door Lock
C-LOCK — \$

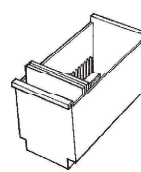

Printer Kit: 12" side panel,
24"x12" shelf, paper slot
P-KIT — \$

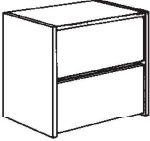
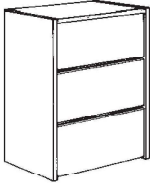

File Drawer Media Bin
holds 24 CD-ROM or
56 3½" Floppy Disks
MB — \$

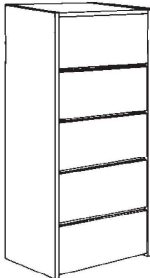
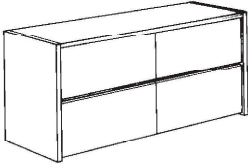
	Express			Express Plus			
	Size (WDH)	Weight	Model No.	Price	Model No.	Price	Features
LATERAL FILES — 1 1/4" CASE							
	Accept letter or legal hanging file folders; heavy-duty Accuride suspensions.						
	30x20x29	185	XLFC 3020		PLFC 3020		<ul style="list-style-type: none"> • Face-mounted gang lock specify F-LOCK2 — add \$
	36x20x29	205	XLFC 3620		PLFC 3620		
	42x20x29	225	XLFC 4220		PLFC 4220		
	30x20x43	240	XLF3 3020		PLF3 3020		<ul style="list-style-type: none"> • Anti-tip mechanism allows only one drawer open at a time • Face-mounted gang lock specify F-LOCK3 — add \$
	36x20x43	270	XLF3 3620		PLF3 3620		
	42x20x43	300	XLF3 4220		PLF3 4220		
	30x20x57	310	XLF4 3020		PLF4 3020		<ul style="list-style-type: none"> • Anti-tip mechanism allows only one drawer open at a time • Face-mounted gang lock specify F-LOCK4 — add \$
	36x20x57	340	XLF4 3620		PLF4 3620		
	42x20x57	370	XLF4 4220		PLF4 4220		
	30x20x72	380	XLF5 3020		PLF5 3020		<ul style="list-style-type: none"> • Four file drawers, flipper door top section • Anti-tip mechanism allows only one drawer open at a time • Face-mounted gang lock specify F-LOCK4 — add \$ • Cam lock for flipper door, C-Lock — add \$
	36x20x72	410	XLF5 3620		PLF5 3620		
	42x20x72	440	XLF5 4220		PLF5 4220		
	60x20x29	345	XLFC 6020		PLFC 6020		<ul style="list-style-type: none"> • Face-mounted gang lock(s) specify F-LOCK2 (L or R) — add \$ per bank (two required to lock all drawers)
	72x20x29	370	XLFC 7220		PLFC 7220		

Denotes Quick Ship item. Available for Quick Ship in eight Quick Ship colors—see finishes.



Express

Express Plus

Size (WDH) Weight Model No. Price Model No. Price Features

LATERAL FILES – 3/4" CASE

Accept letter or legal hanging file folders; heavy-duty Accuride suspensions.

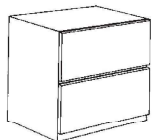

29x20x29	160	XLAC 3020
35x20x29	175	XLAC 3620
41x20x29	190	XLAC 4220

- Face-mounted gang lock specify F-LOCK2 — add \$



29x20x43	205	XLA3 3020
35x20x43	230	XLA3 3620
41x20x43	255	XLA3 4220

- Anti-tip mechanism allows only one drawer open at a time
- Face-mounted gang lock specify F-LOCK3 — add \$



29x20x57	260	XLA4 3020
35x20x57	290	XLA4 3620
41x20x57	320	XLA4 4220

- Anti-tip mechanism allows only one drawer open at a time
- Face-mounted gang lock specify F-LOCK4 — add \$

STORAGE CABINETS

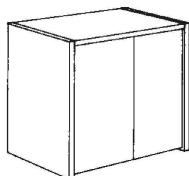

30x20x29	175	XSTR 3020	PSTR 3020
36x20x29	195	XSTR 3620	PSTR 3620
42x20x29	215	XSTR 4220	PSTR 4220

- One adjustable shelf
- Touch latch doors
- Interior fully laminated

Denotes Quick Ship item. Available for Quick Ship in eight Quick Ship colors—see finishes.

OPTIONS

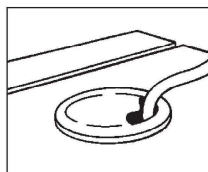

Grommet
FIGROM(x) — \$
indicate location

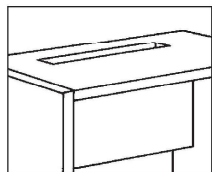

Printer Slot
P-Slot — \$

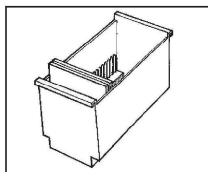

File Drawer Media Bin
holds 24 CD-ROM or
56 3 1/2" Floppy Disks
MB — \$

Size (WDH) Weight Model No. Price Features

PEDESTALS

MOBILE PEDESTALS

All drawer pedestals have fifth caster for stability.

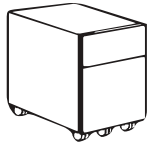

16x18x20½ 60 BFM 1618
 16x22x20½ 70 BFM 1622
 16x28x20½ 80 BFM 1628

- 1 box, 1 file drawer
- Box drawer includes pencil tray

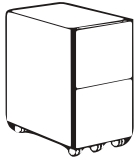

16x18x27 80 FFM 1618
 16x22x27 90 FFM 1622
 16x28x27 100 FFM 1628

- 2 file drawers



16x18x27 85 BBFM 1618
 16x22x27 95 BBFM 1622
 16x28x27 105 BBFM 1628

- 2 box, 1 file drawer
- Top box drawer includes pencil tray



16x18x27 90 4BM 1618
 16x22x27 100 4BM 1622
 16x28x27 110 4BM 1628

- 4 box drawers
- Top box drawer includes pencil tray



16x18x27 65 5DM 1618
 16x22x27 75 5DM 1622
 16x28x27 85 5DM 1628

- 1 door cabinet, hinged right
- Specify left hinge, if required
- One adjustable shelf
- Additional shelves — \$ each

Denotes Quick Ship item. Available for Quick Ship in eight Quick Ship colors—see finishes.

EXPRESS / EXPRESSPLUS

OPTIONS

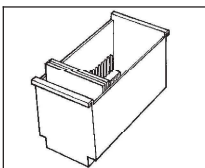

File Drawer Media Bin
 holds 24 CD-ROM or
 56 3½" Floppy Disks
 MB — \$

Size (WDH) Weight Model No. Price Features

PEDESTALS

UNIVERSAL PEDESTALS

Sized to fit beneath desk height units, stand alone as free-standing units or remove 3" base to retrofit existing units or customize other pieces.

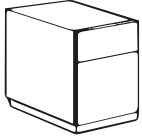

16x18x21 60 BFU 1618
 16x22x21 70 BFU 1622
 16x28x21 80 BFU 1628

- 1 box, 1 file drawer
- Box drawer includes pencil tray

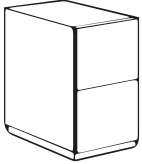

16x18x27½ 80 FFU 1618
 16x22x27½ 90 FFU 1622
 16x28x27½ 100 FFU 1628

- 2 file drawers

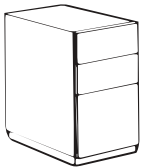

16x18x27½ 85 BBFU 1618
 16x22x27½ 95 BBFU 1622
 16x28x27½ 105 BBFU 1628

- 2 box, 1 file drawer
- Top box drawer includes pencil tray



16x18x27½ 90 4BU 1618
 16x22x27½ 100 4BU 1622
 16x28x27½ 110 4BU 1628

- 4 box drawers
- Top box drawer includes pencil tray

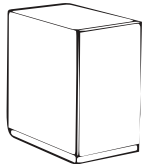

16x18x27½ 65 5DU 1618
 16x22x27½ 75 5DU 1622
 16x28x27½ 85 5DU 1628

- 1 door cabinet, hinged right
- Specify left hinge, if required
- One adjustable shelf
- Additional shelves — \$ each

Denotes Quick Ship item. Available for Quick Ship in eight Quick Ship colors—see finishes.

OPTIONS

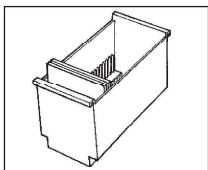

File Drawer Media Bin holds 24 CD-ROM or 56 3½" Floppy Disks MB — \$



Express

Express Plus

Size (WDH) Weight Model No. Price Model No. Price Features

OVERSTORAGE COMPONENTS – WORKSURFACE MOUNTED

Attach to lower units with pass-thru clip/shoulder screw Mod-eze clip system. Metal-to-metal connection assures stability and ease of alignment. ExpressPlus overstorage components are 2½" narrower than indicated dimension and are sized to fit inside reveal due to rounded top edge of ExpressPlus end panels.

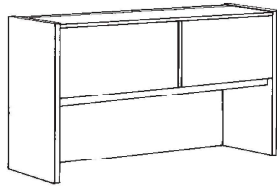

FLIPPER DOOR UNITS

36x17x36	185	XFDU 3636	PFDU 3636
48x17x36	210	XFDU 4836	PFDU 4836
60x17x36	255	XFDU 6036	PFDU 6036
66x17x36	275	XFDU 6636	PFDU 6636
72x17x36	295	XFDU 7236	PFDU 7236
78x17x36	320	XFDU 7836	PFDU 7836
84x17x36	340	XFDU 8436	PFDU 8436

- 36" and 48" w units have one door, others have two
- Doors slide beneath top for safety and utility
- Accepts 21" tackable acoustically treated panel
- 18" clearance beneath valance
- PFDUs are 2½" narrower than indicated dimension

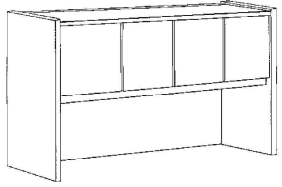

HINGED DOOR UNITS

36x17x36	185	XHDU 3636	PHDU 3636
48x17x36	210	XHDU 4836	PHDU 4836
60x17x36	255	XHDU 6036	PHDU 6036
66x17x36	275	XHDU 6636	PHDU 6636
72x17x36	295	XHDU 7236	PHDU 7236
78x17x36	320	XHDU 7836	PHDU 7836
84x17x36	340	XHDU 8436	PHDU 8436

- 36" and 48" w units have three doors, others have four
- Accepts 21" tackable acoustically treated panel
- 18" clearance beneath valance
- Self-closing Blum hinges
- PHDUs are 2½" narrower than indicated dimension

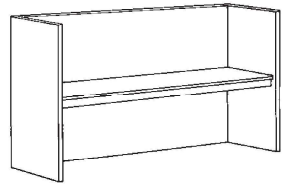

OPEN SHELF UNITS

36x17x30	150	XSHU 3630	PSHU 3630
48x17x30	170	XSHU 4830	PSHU 4830
60x17x30	180	XSHU 6030	PSHU 6030
66x17x30	200	XSHU 6630	PSHU 6630
72x17x30	215	XSHU 7230	PSHU 7230
78x17x30	235	XSHU 7830	PSHU 7830
84x17x30	250	XSHU 8430	PSHU 8430

- Accepts 21" tackable acoustically treated panel
- PSHUs are 2½" narrower than dimension indicated

36x17x36	155	XSHU 3636	PSHU 3636
48x17x36	175	XSHU 4836	PSHU 4836
60x17x36	200	XSHU 6036	PSHU 6036
66x17x36	220	XSHU 6636	PSHU 6636
72x17x36	240	XSHU 7236	PSHU 7236
78x17x36	260	XSHU 7836	PSHU 7836
84x17x36	280	XSHU 8436	PSHU 8436

- Accepts 21" tackable acoustically treated panel
- 18" clearance beneath valance
- PSHUs are 2½" narrower than indicated dimension

See page 56 for tackable panel options.

Denotes Quick Ship item. Available for Quick Ship in eight Quick Ship colors—see finishes.

OPTIONS

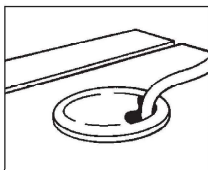

Grommet FIGROM(x) — \$ indicate location

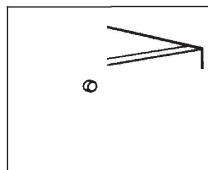

Door Lock C-LOCK — \$

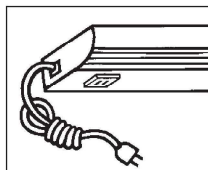

Task Light LITE0024 24" w — \$ LITE0048 48" w — \$

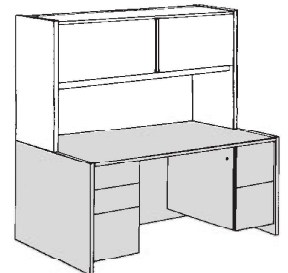
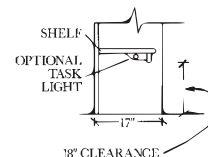

EXPRESS / EXPRESSPLUS



Express

ExpressPlus

Size (WDH) Weight Model No. Price Model No. Price Features

OVERSTORAGE UNITS – WALLMOUNT

All units have recessed back with concealed wood cleat wall mount strip.

Note: Wall conditions encountered in field vary greatly. The installer should verify that wall conditions and hardware utilized are sufficient to carry weight of loaded cabinet.

All units have 2½" h fascia strip to conceal optional task light.

BUCKET SHELF UNITS



36x17x16	50	XWMO 3617	PWMO 3617
42x17x16	55	XWMO 4217	PWMO 4217
48x17x16	60	XWMO 4817	PWMO 4817
60x17x16	70	XWMO 6017	PWMO 6017
66x17x16	75	XWMO 6617	PWMO 6617
72x17x16	80	XWMO 7217	PWMO 7217

FLIPPER DOOR UNITS

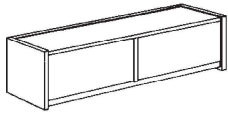

36x17x16	60	XWFD 3617	PWFD 3617
42x17x16	65	XWFD 4217	PWFD 4217
48x17x16	70	XWFD 4817	PWFD 4817
60x17x16	80	XWFD 6017	PWFD 6017
66x17x16	85	XWFD 6617	PWFD 6617
72x17x16	90	XWFD 7217	PWFD 7217

- 36", 42", 48" w units have one door, others have two

HINGE DOOR UNITS

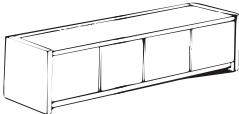

36x17x16	60	XWHD 3617	PWHD 3617
42x17x16	65	XWHD 4217	PWHD 4217
48x17x16	70	XWHD 4817	PWHD 4817
60x17x16	80	XWHD 6017	PWHD 6017
66x17x16	85	XWHD 6617	PWHD 6617
72x17x16	90	XWHD 7217	PWHD 7217

- 36", 42", 48" w units have three doors, others have four
- Self-closing Blum hinges

TACKABLE PANELS



33½x¾x21	5	TACK 3421	TARK 3121
45½x¾x21	5	TACK 4621	TARK 4321
57½x¾x21	10	TACK 5821	TARK 5521
63½x¾x21	10	TACK 6421	TARK 6121
69½x¾x21	15	TACK 7021	TARK 6721
75½x¾x21	15	TACK 7621	TARK 7321
81½x¾x21	15	TACK 8221	TARK 7921

- Use with overstorage units for tackability, acoustical effect
- Available in Guilford 701 Series, Pattern 2100
- TARKs are 2½" narrower than indicated dimension
- Use TARKs with PFDU, PHDU, PSHU components.

Denotes Quick Ship item. Available for Quick Ship in eight Quick Ship colors—see finishes.

OPTIONS

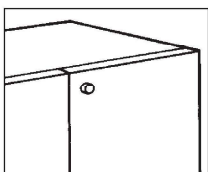

Door Lock
C-LOCK — \$

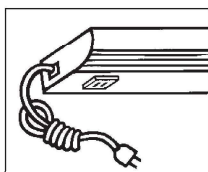

Task Light
LITE0024 24" w — \$
LITE0048 48" w — \$

Size (WDH) Weight Model No. Price COM*

S C R E E N S

Screens may be combined with any of the modular casegood items in the Express Series to provide visual and acoustical privacy. Screens mount easily into end panels and worksurfaces with a heavy-duty steel post mechanism. They may be readily removed to provide conferencing capabilities. Pricing is based on Guilford 701 Series fabrics, Pattern 2100.

Note: Due to the rounded panels of the ExpressPlus Series, screens may not be suitable for some applications. Consult factory.

Note: For in-between sizes, use next largest size for pricing.

15" HIGH SCREENS



20x1¼x15	9	SCRN 2015	½ yd
24x1¼x15	10	SCRN 2415	½ yd
30x1¼x15	13	SCRN 3015	½ yd
36x1¼x15	15	SCRN 3615	1 yd
42x1¼x15	18	SCRN 4215	1 yd
48x1¼x15	20	SCRN 4815	1 yd
54x1¼x15	23	SCRN 5415	1 yd
60x1¼x15	25	SCRN 6015	1 yd
66x1¼x15	28	SCRN 6615	2 yd
72x1¼x15	30	SCRN 7215	2¼ yd

22" HIGH SCREENS

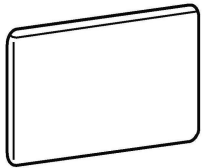

20x1¼x22	13	SCRN 2022	¾ yd
24x1¼x22	15	SCRN 2422	¾ yd
30x1¼x22	19	SCRN 3022	¾ yd
36x1¼x22	22	SCRN 3622	1½ yd
42x1¼x22	26	SCRN 4222	1½ yd
48x1¼x22	30	SCRN 4822	1½ yd
54x1¼x22	33	SCRN 5422	1½ yd
60x1¼x22	37	SCRN 6022	1½ yd
66x1¼x22	41	SCRN 6622	2 yd
72x1¼x22	44	SCRN 7222	2¼ yd

36" HIGH SCREENS

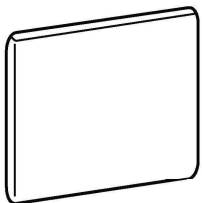

20x1¼x36	20	SCRN 2036	1¼ yd
24x1¼x36	24	SCRN 2436	1¼ yd
30x1¼x36	30	SCRN 3036	1¼ yd
36x1¼x36	36	SCRN 3636	2¼ yd
42x1¼x36	42	SCRN 4236	2¼ yd
48x1¼x36	48	SCRN 4836	2¼ yd
54x1¼x36	54	SCRN 5436	2¼ yd
60x1¼x36	60	SCRN 6036	2¼ yd
66x1¼x36	66	SCRN 6636	4¼ yd
72x1¼x36	72	SCRN 7236	4½ yd

*COM yardage based on 66" w, non-directional fabric. COM material must be approved by HLF before an order can be accepted. All COM material must be shipped to HLF prepaid.

Denotes Quick Ship item. Available for Quick Ship in eight Quick Ship colors—see finishes.

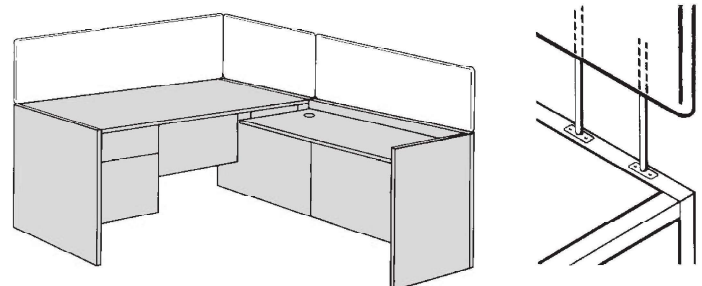

EXPRESS / EXPRESSPLUS



Express

ExpressPlus

Size (WDH) Weight Model No. Price Model No. Price Features

RECEPTION STATIONS

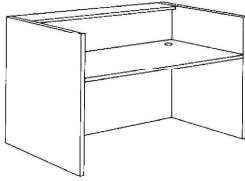

DESK SHELLS WITH 6" RECESSED FACE PANEL

60x30x42	260	XRED 6030	PRED 6030
66x30x42	290	XRED 6630	PRED 6630
72x30x42	320	XRED 7230	PRED 7230
72x36x42	360	XRED 7236	PRED 7236

- 10" d transaction ledge
- 29" AFF worksurface
- Grommet each side
- Unhanded — accepts left or right return
- 30" d units accept 22" d pedestals — see p.53
- 36" d units accept 28" d pedestals — see p.53

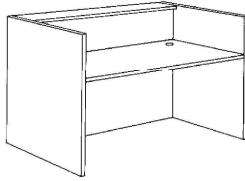

DESK SHELLS WITH 1/4" RECESSED FACE PANEL

60x30x42	280	XFED 6030	PFED 6030
66x30x42	310	XFED 6630	PFED 6630
72x30x42	340	XFED 7230	PFED 7230
72x36x42	380	XFED 7236	PFED 7236

- 10" d transaction ledge
- 29" AFF worksurface
- Grommet each side
- Unhanded — accepts left or right return
- Accept 28" d pedestals — see p.53

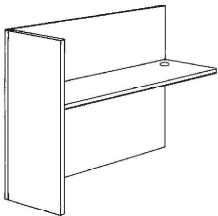

RETURNS—LEFT HAND

36x20x42	150	XROL 3620	PROL 3620
42x20x42	160	XROL 4220	PROL 4220
48x20x42	170	XROL 4820	PROL 4820
60x20x42	200	XROL 6020	PROL 6020
36x24x42	160	XROL 3624	PROL 3624
42x24x42	170	XROL 4224	PROL 4224
48x24x42	180	XROL 4824	PROL 4824
60x24x42	210	XROL 6024	PROL 6024

- 29" AFF worksurface
- Grommet
- Accepts 18" d pedestal — see p.53

- Accepts 22" d pedestal — see p.53

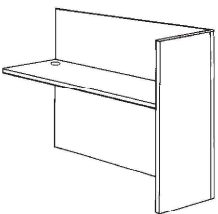

RETURNS—RIGHT HAND

36x20x42	150	XROR 3620	PROR 3620
42x20x42	160	XROR 4220	PROR 4220
48x20x42	170	XROR 4820	PROR 4820
60x20x42	200	XROR 6020	PROR 6020
36x24x42	160	XROR 3624	PROR 3624
42x24x42	170	XROR 4224	PROR 4224
48x24x42	180	XROR 4824	PROR 4824
60x24x42	210	XROR 6024	PROR 6024

- 29" AFF worksurface
- Grommet
- Accepts 18" d pedestal — see p.53

Denotes Quick Ship item. Available for Quick Ship in eight Quick Ship colors—see finishes.

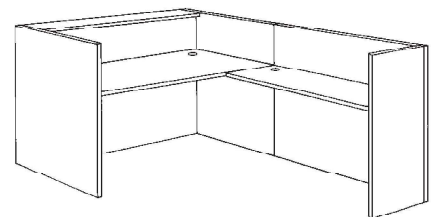
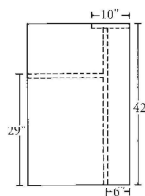

OPTIONS

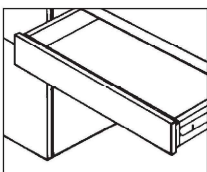

Pencil Drawer PD — \$

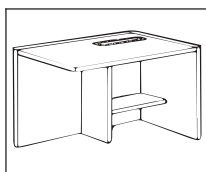

Printer Kit: 12" Side Panel, 24"x12" Shelf, Paper Slot P-KIT — \$

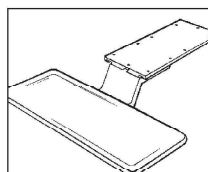

Slide-Out Keyboard with Center Mount Slide and Molded Tray ZOK — \$

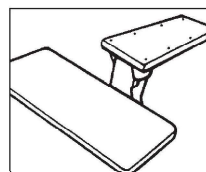

Articulating Keyboard with Molded Tray ART-M — \$

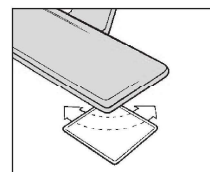

Mouse Pad Extension mounts to ZOK or ART-M MPE — \$

WOODSTOCK:

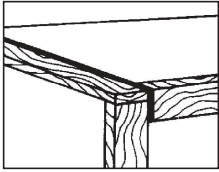



GENERAL SERIES FEATURES

- 1 1/4" slab construction.
- Edges of worksurfaces and end panels capped in 1/4"x1 1/4" oak or mahogany, as specified.
- 45 lb. density industrial particle board substrate.
- Leveling glides on all units.
- All wood drawer construction with black vinyl wrap.
- Accuride® suspensions on all drawers.
- Most vertical file drawers accommodate both letter and legal size hanging folder files. Vertical file drawers on 20"d returns and credenzas file letter only.
- Fully modular construction.
- Blum® hinges on all doors.
- Full case pedestal construction.
- Light and medium oak, ebony on oak, mahogany on mahogany, and cherry on mahogany are standard. These approximate HLF standard laminates (i.e., OAK-71 = H-71 Light Oak, etc.).
- Custom finishes and wood species available — consult factory for specifics and pricing.

TABLE OF CONTENTS

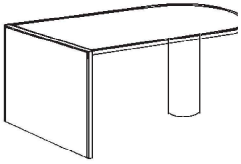
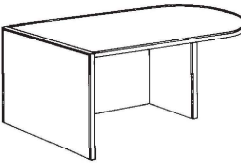
ITEM	PAGE
Cabinets, storage	74
Credenzas	73
Desks, bullet.....	60
Desks, conference	61
Desks, double pedestal.....	72
Desks, reception	80
Desks, single pedestal	62
Filing cabinets, lateral.....	74
Filing cabinets, mobile.....	75
Overstorage, wall mounted.....	78
Overstorage, worksurface mounted	77
Pedestals, freestanding	76
Pedestals, mobile	75
Returns, corner units.....	66, 70
Returns, executive height	63-66
Returns, reception	80
Returns, secretarial/machine height.....	67-70
Screens	79
Tables, computer	71
Tables, machine stands	71
Tables, printer.....	71
Tackable panels	78

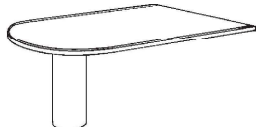
	Size (WDH)	Weight	Model No.	Price	Features
BULLET DESKS					
	60x30x29	200	SOBD 6030		<ul style="list-style-type: none"> • 12" support panel centered on leg • Unhanded — accepts left or right return • 12" diameter cylinder support
	66x30x29	210	SOBD 6630		
	72x30x29	220	SOBD 7230		
	72x36x29	235	SOBD 7236		
<hr/>					
	60x30x29	225	SMBD 6030L		<ul style="list-style-type: none"> • Full modesty panel • Accepts left hand return
	66x30x29	240	SMBD 6630L		
	72x30x29	250	SMBD 7230L		
	72x36x29	270	SMBD 7236L		
<hr/>					
	60x30x29	225	SMBD 6030R		<ul style="list-style-type: none"> • Full modesty panel • Accepts right hand return
	66x30x29	240	SMBD 6630R		
	72x30x29	250	SMBD 7230R		
	72x36x29	270	SMBD 7236R		
<hr/>					
BULLET RUNOFF DESKS					
	60x30x29	140	SBRO 6030		<ul style="list-style-type: none"> • Unhanded • Not for freestanding applications • Attaches to adjacent unit with heavy-duty metal flat plate • 12" diameter cylinder support
	66x30x29	150	SBRO 6630		
	72x30x29	160	SBRO 7230		

WOODSTOCK

OPTIONS

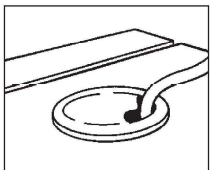



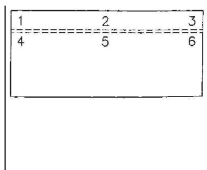



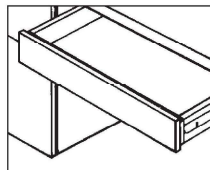

Grommet
FIGROM(x) — \$
indicate location

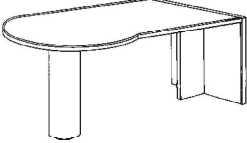

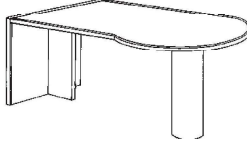
Grommet Locator

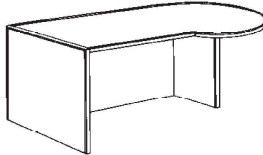
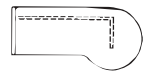
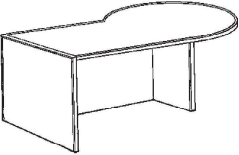

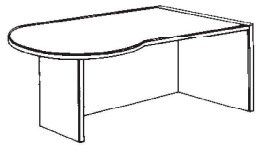
Pencil Drawer
PD — \$

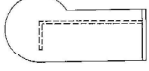
	Size (WDH)	Weight	Model No.	Price	Features	
CONFERENCE DESKS ("P"-DESKS)						
	Indicated depth is overall depth — straight section of top is 6" narrower.					
	72x36x29	215	SOCD 7236A		• 12" diameter cylinder support	
	84x36x29	230	SOCD 8436A		• 12" support panel centered on leg	
	84x42x29	255	SOCD 8442A			
	72x36x29	215	SOCD 7236B		• 12" diameter cylinder support	
	84x36x29	230	SOCD 8436B		• 12" support panel centered on leg	
	84x42x29	255	SOCD 8442B			
	72x36x29	235	SMCD 7236LI		• Full modesty panel	
	84x36x29	265	SMCD 8436LI		• Accepts left hand return	
	84x42x29	295	SMCD 8442LI		• Conference round faces in	
	72x36x29	235	SMCD 7236LO		• Full modesty panel	
	84x36x29	265	SMCD 8436LO		• Accepts left hand return	
	84x42x29	295	SMCD 8442LO		• Conference round faces out	
	72x36x29	235	SMCD 7236RI		• Full modesty panel	
	84x36x29	265	SMCD 8436RI		• Accepts right hand return	
	84x42x29	295	SMCD 8442RI		• Conference round faces in	
	72x36x29	235	SMCD 7236RO		• Full modesty panel	
	84x36x29	265	SMCD 8436RO		• Accepts right hand return	
	84x42x29	295	SMCD 8442RO		• Conference round faces out	

WOODSTOCK

OPTIONS

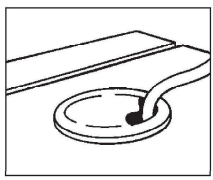

Grommet
FIGROM(x) — \$
indicate location

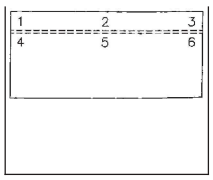

Grommet Locator

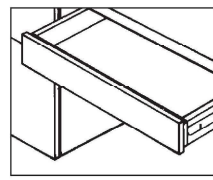

Pencil Drawer
PD — \$

	Size (WDH)	Weight	Model No.	Price	Features
--	------------	--------	-----------	-------	----------

SINGLE PEDESTAL DESKS

48" w desks will not accept returns, 60" w desk will not accept 24" d returns.

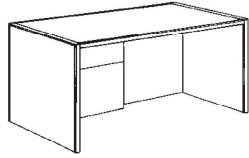

48x24x29	230	SSPD 4824L
48x30x29	250	SSPD 4830L
60x30x29	280	SSPD 6030L
66x30x29	285	SSPD 6630L
72x30x29	300	SSPD 7230L
72x36x29	320	SSPD 7236L

- Left hand pedestal
- Accepts right hand return
- 1 box, 1 file drawer
- Drop lock included
- Full modesty panel recessed 6", except 24" d has flush panel

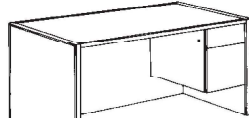

48x24x29	230	SSPD 4824R
48x30x29	250	SSPD 4830R
60x30x29	280	SSPD 6030R
66x30x29	285	SSPD 6630R
72x30x29	300	SSPD 7230R
72x36x29	320	SSPD 7236R

- Right hand pedestal
- Accepts left hand return
- 1 box, 1 file drawer
- Drop lock included
- Full modesty panel recessed 6", except 24" d has flush panel

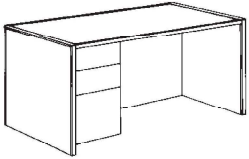

48x24x29	260	SCBF 4824L
48x30x29	280	SCBF 4830L
60x30x29	300	SCBF 6030L
66x30x29	310	SCBF 6630L
72x30x29	315	SCBF 7230L
72x36x29	340	SCBF 7236L

- Left hand pedestal
- Accepts right hand return
- 2 box, 1 file drawer
- Drop lock included
- Full modesty panel recessed 6", except 24" d has flush panel

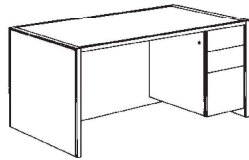

48x24x29	260	SCBF 4824R
48x30x29	280	SCBF 4830R
60x30x29	300	SCBF 6030R
66x30x29	310	SCBF 6630R
72x30x29	315	SCBF 7230R
72x36x29	340	SCBF 7236R

- Right hand pedestal
- Accepts left hand return
- 2 box, 1 file drawer
- Drop lock included
- Full modesty panel recessed 6", except 24" d has flush panel

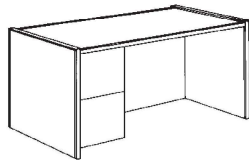

48x24x29	260	SCFF 4824L
48x30x29	280	SCFF 4830L
60x30x29	300	SCFF 6030L
66x30x29	310	SCFF 6630L
72x30x29	315	SCFF 7230L
72x36x29	340	SCFF 7236L

- Left hand pedestal
- Accepts right hand return
- 2 file drawers
- Drop lock included
- Full modesty panel recessed 6", except 24" d has flush panel

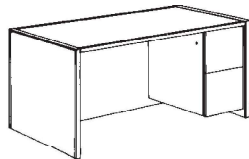

48x24x29	260	SCFF 4824R
48x30x29	280	SCFF 4830R
60x30x29	300	SCFF 6030R
66x30x29	310	SCFF 6630R
72x30x29	315	SCFF 7230R
72x36x29	340	SCFF 7236R

- Right hand pedestal
- Accepts left hand return
- 2 file drawers
- Drop lock included
- Full modesty panel recessed 6", except 24" d has flush panel

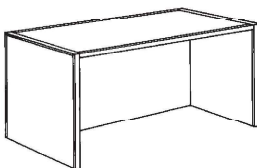

48x24x29	170	STD M 4824
48x30x29	190	STD M 4830
60x30x29	210	STD M 6030
66x30x29	230	STD M 6630
72x30x29	235	STD M 7230
72x36x29	265	STD M 7236

- Open desk shell
- Full modesty panel recessed 6", except 24" d has flush panel

OPTIONS

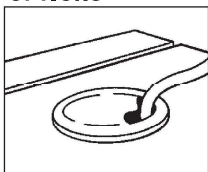

Grommet
FIGROM(x) — \$
indicate location

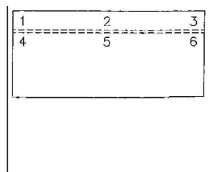

Grommet Locator

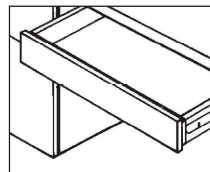

Pencil Drawer
PD — \$

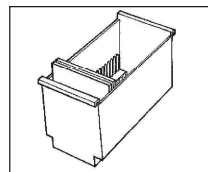

File Drawer Media Bin
holds 24 CD-ROM or
56 3½" Floppy Disks
MB — \$

Size (WDH) Weight Model No. Price Features

EXECUTIVE RETURNS

Worksurface height 29" AFF

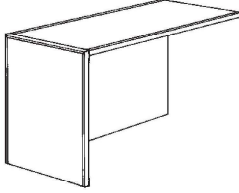

OPEN RETURNS—LEFT HAND

30x20x29	115	SOOE 3020L
36x20x29	120	SOOE 3620L
42x20x29	140	SOOE 4220L
48x20x29	145	SOOE 4820L
60x20x29	170	SOOE 6020L
72x20x29	195	SOOE 7220L

30x24x29	125	SOOE 3024L
36x24x29	135	SOOE 3624L
42x24x29	150	SOOE 4224L
48x24x29	160	SOOE 4824L
60x24x29	185	SOOE 6024L
72x24x29	210	SOOE 7224L

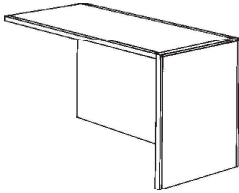

OPEN RETURNS—RIGHT HAND

30x24x29	115	SOOE 3020R
36x20x29	120	SOOE 3620R
42x20x29	140	SOOE 4220R
48x20x29	145	SOOE 4820R
60x20x29	170	SOOE 6020R
72x20x29	195	SOOE 7220R

30x24x29	125	SOOE 3024R
36x24x29	135	SOOE 3624R
42x24x29	150	SOOE 4224R
48x24x29	160	SOOE 4824R
60x24x29	185	SOOE 6024R
72x24x29	210	SOOE 7224R

RETURNS WITH STATIONERY CABINET—LEFT HAND

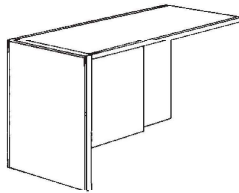

36x20x29	170	SSOE 3620L
42x20x29	190	SSOE 4220L
48x20x29	195	SSOE 4820L
60x20x29	220	SSOE 6020L
72x20x29	245	SSOE 7220L

• 4 adjustable shelves

36x24x29	185	SSOE 3624L
42x24x29	200	SSOE 4224L
48x24x29	210	SSOE 4824L
60x24x29	235	SSOE 6024L
72x24x29	260	SSOE 7224L

WOODSTOCK

Special Widths and Depths:

For in-between widths, specify letter code of desired model followed by SPECIAL (i.e., SOOS-SPECIAL) and indicated desired size — add 10% to price of next largest standard size. For in-between or custom depths, consult factory for availability, specification and pricing information.

OPTIONS

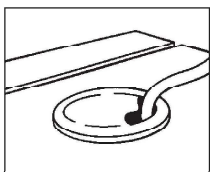

Grommet FIGROM(x) — \$ indicate location

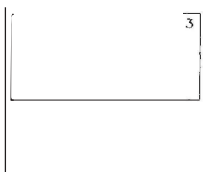

Grommet Locator

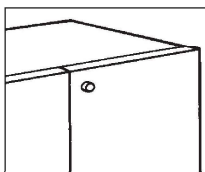

Door Lock C-LOCK — \$

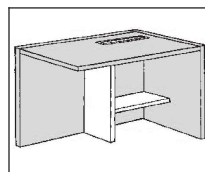

Printer Kit: 12" Side Panel, 24"x12" Shelf, Paper Slot P-KIT — \$

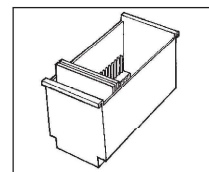

File Drawer Media Bin holds 24 CD-ROM or 56 3½" Floppy Disks MB — \$

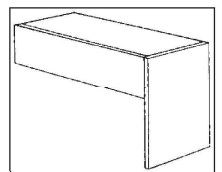

Short Back Panel — 8" h 8HI — \$

Size (WDH)	Weight	Model No.	Price	Features
------------	--------	-----------	-------	----------

EXECUTIVE RETURNS

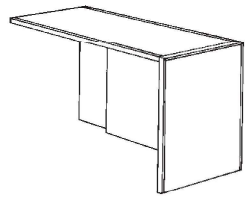

RETURNS WITH STATIONERY CABINET—RIGHT HAND

36x20x29	170	SSOE 3620R		• 4 adjustable shelves
42x20x29	190	SSOE 4220R		
48x20x29	195	SSOE 4820R		
60x20x29	220	SSOE 6020R		
72x20x29	245	SSOE 7220R		

36x24x29	185	SSOE 3624R	
42x24x29	200	SSOE 4224R	
48x24x29	210	SSOE 4824R	
60x24x29	235	SSOE 6024R	
72x24x29	260	SSOE 7224R	

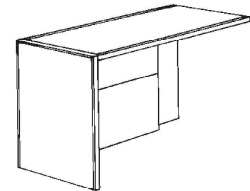

RETURNS WITH BOX, FILE PEDESTALS—LEFT HAND

36x20x29	180	SFOE 3620L	
42x20x29	200	SFOE 4220L	
48x20x29	205	SFOE 4820L	
60x20x29	230	SFOE 6020L	
72x20x29	255	SFOE 7220L	

36x24x29	205	SFOE 3624L	
42x24x29	220	SFOE 4224L	
48x24x29	230	SFOE 4824L	
60x24x29	255	SFOE 6024L	
72x24x29	280	SFOE 7224L	

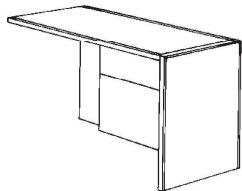

RETURNS WITH BOX, FILE PEDESTALS—RIGHT HAND

36x20x29	180	SFOE 3620R	
42x20x29	200	SFOE 4220R	
48x20x29	205	SFOE 4820R	
60x20x29	230	SFOE 6020R	
72x20x29	255	SFOE 7220R	

36x24x29	205	SFOE 3624R	
42x24x29	220	SFOE 4224R	
48x24x29	230	SFOE 4824R	
60x24x29	255	SFOE 6024R	
72x24x29	280	SFOE 7224R	

WOODSTOCK

Special Widths and Depths:
 For in-between widths, specify letter code of desired model followed by SPECIAL (i.e., SOOS-SPECIAL) and indicated desired size — add 10% to price of next largest standard size. For in-between or custom depths, consult factory for availability, specification and pricing information.

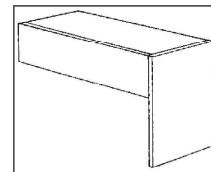

Short Back Panel
 — 8" h 8HI — \$

OPTIONS

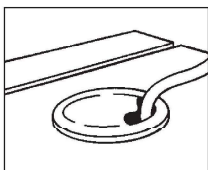

Grommet
 FIGROM(x) — \$
 indicate location

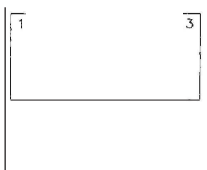

Grommet Locator

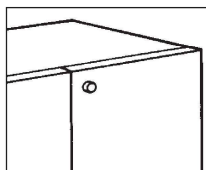

Door Lock
 C-LOCK — \$

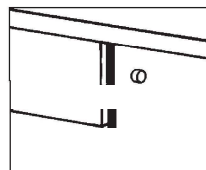

Pedestal Lock
 D-LOCK — \$

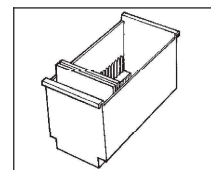

File Drawer Media Bin
 holds 24 CD-ROM or
 56 3½" Floppy Disks
 MB — \$

Size (WDH) Weight Model No. Price Features

EXECUTIVE RETURNS

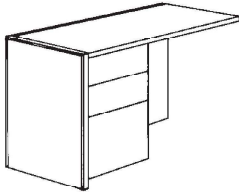

RETURNS WITH BOX, BOX, FILE PEDESTAL—LEFT HAND

36x20x29	205	SBBE 3620L
42x20x29	225	SBBE 4220L
48x20x29	230	SBBE 4820L
60x20x29	255	SBBE 6020L
72x20x29	280	SBBE 7220L

36x24x29	230	SBBE 3624L
42x24x29	245	SBBE 4224L
48x24x29	255	SBBE 4824L
60x24x29	280	SBBE 6024L
72x24x29	305	SBBE 7224L

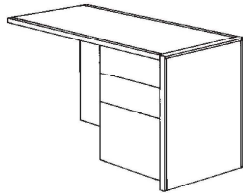

RETURNS WITH BOX, BOX, FILE PEDESTAL—RIGHT HAND

36x20x29	205	SBBE 3620R
42x20x29	225	SBBE 4220R
48x20x29	230	SBBE 4820R
60x20x29	255	SBBE 6020R
72x20x29	280	SBBE 7220R

36x24x29	230	SBBE 3624R
42x24x29	245	SBBE 4224R
48x24x29	255	SBBE 4824R
60x24x29	280	SBBE 6024R
72x24x29	305	SBBE 7224R

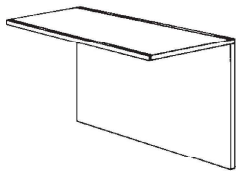

OPEN BRIDGE RETURNS (UNHANDED)

36x20x29	100	SBRE 3620
42x20x29	115	SBRE 4220
48x20x29	125	SBRE 4820
54x20x29	140	SBRE 5420
60x20x29	150	SBRE 6020
72x20x29	170	SBRE 7220

• Units 60" or wider have half-panel support

36x24x29	110	SBRE 3624
42x24x29	125	SBRE 4224
48x24x29	140	SBRE 4824
54x24x29	155	SBRE 5424
60x24x29	165	SBRE 6024
72x24x29	180	SBRE 7224

• Units 60" or wider have half-panel support

Special Widths and Depths:
For in-between widths, specify letter code of desired model followed by SPECIAL (i.e., SOOS-SPECIAL) and indicated desired size — add 10% to price of next largest standard size. For in-between or custom depths, consult factory for availability, specification and pricing information.

OPTIONS

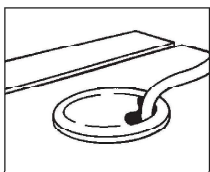

Grommet
FIGROM(x) — \$
indicate location

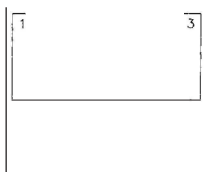

Grommet Locator

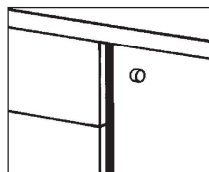

Pedestal Lock
D-LOCK — \$

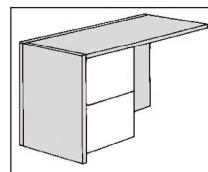

File/file Pedestal
specify SBBE-FF

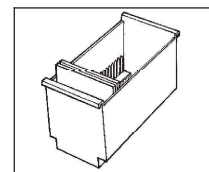

File Drawer Media Bin
holds 24 CD-ROM or
56 3½" Floppy Disks
MB — \$

Size (WDH) Weight Model No. Price Features

EXECUTIVE RETURNS

EXECUTIVE HEIGHT CORNER EXTENSIONS

Note: Open extensions are not freestanding. They may be used between two other components or they may be attached to a single other component if a panel end is added to the open end. A panel end will add 1¼" to the size of the unit. Support panels should be added where corner extensions abut open or bridge returns or pedestal returns wider than 48".

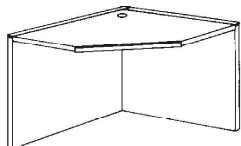

36x36x29	165	SCRE 3636
36x42x29	185	SCRE 3642A
42x36x29	185	SCRE 4236B
36x42x29	185	SCRE 3642C
42x36x29	185	SCRE 4236D
42x42x29	200	SCRE 4242
48x48x29	240	SCRE 4848

• *Corner grommet is standard*

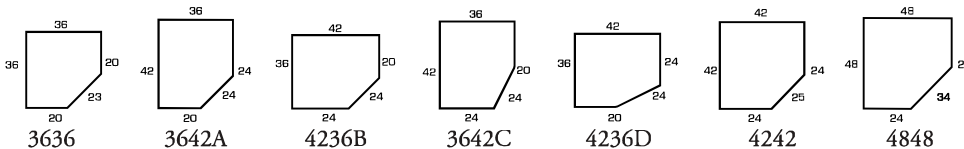

LEGS



20x1¼x29	40	SLEG 2029
24x1¼x29	45	SLEG 2429
30x1¼x29	50	SLEG 3029
36x1¼x29	55	SLEG 3629

SUPPORT PANELS



12x1¼x27¾	15	SSP 1227
15x1¼x27¾	20	SSP 1527

OPTIONS

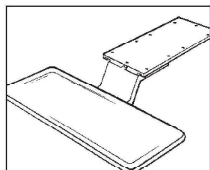

Slide-out Keyboard with Center Mount Slide and Molded Tray
ZOK — \$

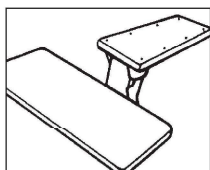

Articulating Keyboard with Molded Tray
ART-M — \$

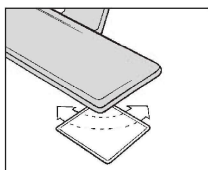

Mouse Pad Extension mounts to ZOK or ART-M MPE — \$

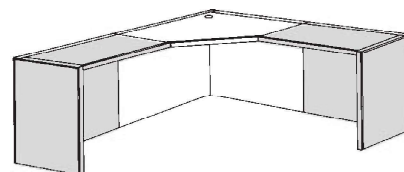

Size (WDH) Weight Model No. Price Features

SECRETARIAL RETURNS

Worksurface height 26" AFF, 3" h gallery rail.

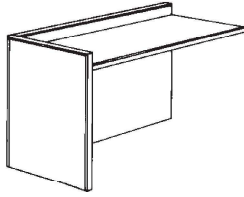

OPEN RETURNS—LEFT HAND

30x20x29	115	SOOS 3020L
36x20x29	120	SOOS 3620L
42x20x29	140	SOOS 4220L
48x20x29	145	SOOS 4820L
60x20x29	170	SOOS 6020L
72x20x29	195	SOOS 7220L

30x24x29	125	SOOS 3024L
36x24x29	135	SOOS 3624L
42x24x29	150	SOOS 4224L
48x24x29	160	SOOS 4824L
60x24x29	185	SOOS 6024L
72x24x29	210	SOOS 7224L

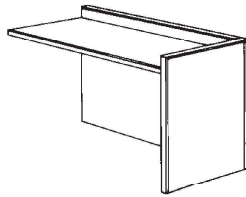

OPEN RETURNS—RIGHT HAND

30x20x29	115	SOOS 3020R
36x20x29	120	SOOS 3620R
42x20x29	140	SOOS 4220R
48x20x29	145	SOOS 4820R
60x20x29	170	SOOS 6020R
72x20x29	195	SOOS 7220R

30x24x29	125	SOOS 3024R
36x24x29	135	SOOS 3624R
42x24x29	150	SOOS 4224R
48x24x29	160	SOOS 4824R
60x24x29	185	SOOS 6024R
72x24x29	210	SOOS 7224R

RETURNS WITH STATIONERY CABINET—LEFT HAND

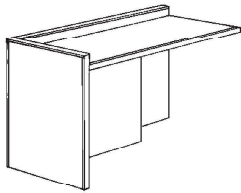

36x20x29	170	SSOS 3620L
42x20x29	190	SSOS 4220L
48x20x29	195	SSOS 4820L
60x20x29	220	SSOS 6020L
72x20x29	245	SSOS 7220L

• 4 adjustable shelves

36x24x29	185	SSOS 3624L
42x24x29	200	SSOS 4224L
48x24x29	210	SSOS 4824L
60x24x29	235	SSOS 6024L
72x24x29	260	SSOS 7224L

WOODSTOCK

Special Widths and Depths:

For in-between widths, specify letter code of desired model followed by SPECIAL (i.e., SOOS-SPECIAL) and indicated desired size — add 10% to price of next largest standard size. For in-between or custom depths, consult factory for availability, specification and pricing information.

OPTIONS

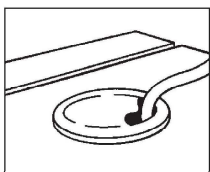

Grommet
FIGROM(x) — \$
indicate location

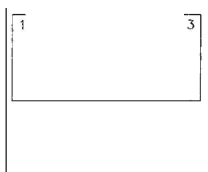

Grommet Locator

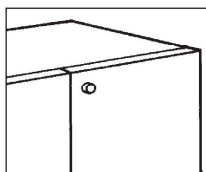

Door Lock
C-LOCK — \$

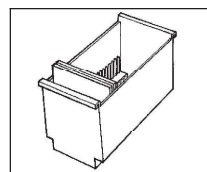

File Drawer Media Bin
holds 24 CD-ROM or
56 3½" Floppy Disks
MB — \$

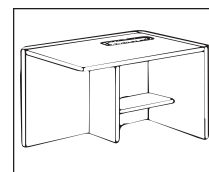

Printer Kit: 12" Side Panel,
24"x12" Shelf, Paper Slot
P-KIT — \$

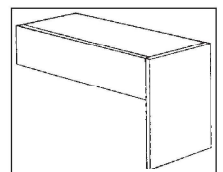

Short Back Panel — 8" h
8HI — \$

Size (WDH) Weight Model No. Price Features

SECRETARIAL RETURNS

RETURNS WITH STATIONERY CABINET—RIGHT HAND

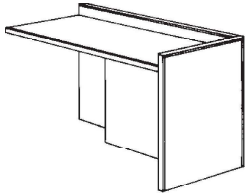

36x20x29	170	SSOS 3620R	• 4 adjustable shelves
42x20x29	190	SSOS 4220R	
48x20x29	195	SSOS 4820R	
60x20x29	220	SSOS 6020R	
72x20x29	245	SSOS 7220R	

36x24x29	185	SSOS 3624R
42x24x29	200	SSOS 4224R
48x24x29	210	SSOS 4824R
60x24x29	235	SSOS 6024R
72x24x29	260	SSOS 7224R

RETURNS WITH BOX, FILE PEDESTALS—LEFT HAND

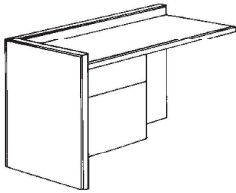

36x20x29	180	SFOS 3620L
42x20x29	200	SFOS 4220L
48x20x29	205	SFOS 4820L
60x20x29	230	SFOS 6020L
72x20x29	255	SFOS 7220L

36x24x29	205	SFOS 3624L
42x24x29	220	SFOS 4224L
48x24x29	230	SFOS 4824L
60x24x29	255	SFOS 6024L
72x24x29	280	SFOS 7224L

RETURNS WITH BOX, FILE PEDESTALS—RIGHT HAND

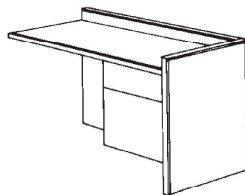

36x20x29	180	SFOS 3620R
42x20x29	200	SFOS 4220R
48x20x29	205	SFOS 4820R
60x20x29	230	SFOS 6020R
72x20x29	255	SFOS 7220R

36x24x29	205	SFOS 3624R
42x24x29	220	SFOS 4224R
48x24x29	230	SFOS 4824R
60x24x29	255	SFOS 6024R
72x24x29	280	SFOS 7224R

WOODSTOCK

Special Widths and Depths:
 For in-between widths, specify letter code of desired model followed by SPECIAL (i.e., SOOS-SPECIAL) and indicated desired size — add 10% to price of next largest standard size. For in-between or custom depths, consult factory for availability, specification and pricing information.

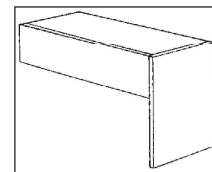

Short Back Panel — 8" h 8H1 — \$

OPTIONS

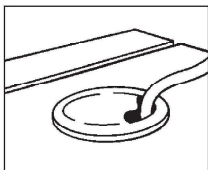

Grommet FIGROM(x) — \$ indicate location

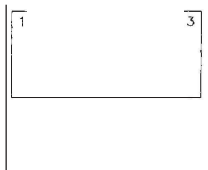

Grommet Locator

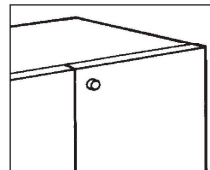

Door Lock C-LOCK — \$

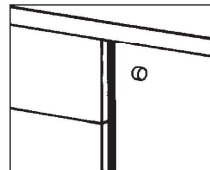

Pedestal Lock D-LOCK — \$

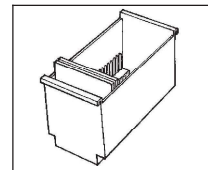

File Drawer Media Bin holds 24 CD-ROM or 56 3½" Floppy Disks MB — \$

Size (WDH) Weight Model No. Price Features

SECRETARIAL RETURNS

RETURNS WITH 3 BOX DRAWERS—LEFT HAND

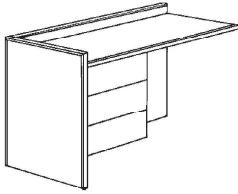

36x20x29	180	SBOS 3620L
42x20x29	200	SBOS 4220L
48x20x29	205	SBOS 4820L
60x20x29	230	SBOS 6020L
72x20x29	255	SBOS 7220L

36x24x29	205	SBOS 3624L
42x24x29	220	SBOS 4224L
48x24x29	230	SBOS 4824L
60x24x29	255	SBOS 6024L
72x24x29	280	SBOS 7224L

RETURNS WITH 3 BOX DRAWERS—RIGHT HAND

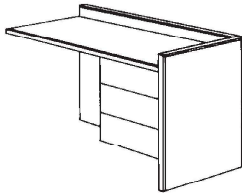

36x20x29	180	SBOS 3620R
42x20x29	200	SBOS 4220R
48x20x29	205	SBOS 4820R
60x20x29	230	SBOS 6020R
72x20x29	255	SBOS 7220R

36x24x29	205	SBOS 3624R
42x24x29	220	SBOS 4224R
48x24x29	230	SBOS 4824R
60x24x29	255	SBOS 6024R
72x24x29	280	SBOS 7224R

OPEN BRIDGE RETURNS (UNHANDED)

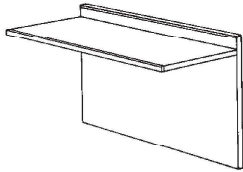

36x20x29	100	SBRS 3620
42x20x29	115	SBRS 4220
48x20x29	125	SBRS 4820
54x20x29	140	SBRS 5420
60x20x29	150	SBRS 6020
72x20x29	170	SBRS 7220

• Units 60" or wider have half-panel support

36x24x29	110	SBRS 3624
42x24x29	125	SBRS 4224
48x24x29	140	SBRS 4824
54x24x29	155	SBRS 5424
60x24x29	165	SBRS 6024
72x24x29	180	SBRS 7224

• Units 60" or wider have half-panel support

Special Widths and Depths:

For in-between widths, specify letter code of desired model followed by *SPECIAL* (i.e., *SOOS-SPECIAL*) and indicated desired size — add 10% to price of next largest standard size. For in-between or custom depths, consult factory for availability, specification and pricing information.

OPTIONS

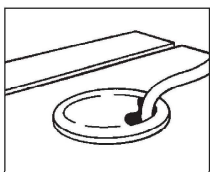

Grommet
FIGROM(x) — \$
indicate location

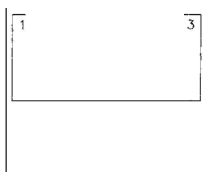

Grommet Locator

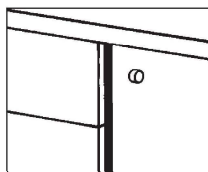

Pedestal Lock
D-LOCK — \$

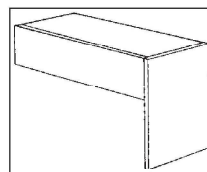

Short Back Panel —
8" h 8HI — \$

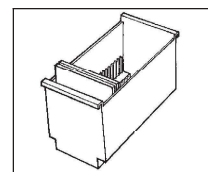

File Drawer Media Bin
holds 24 CD-ROM or
56 3½" Floppy Disks
MB — \$

Size (WDH) Weight Model No. Price Features

SECRETARIAL RETURNS

SECRETARIAL HEIGHT CORNER EXTENSIONS

Note: Open extensions are not freestanding. They may be used between two other components or they may be attached to a single other component if a panel end is added to the open end. A panel end will add 1¼" to the size of the unit. Support panels should be added where corner extensions abut open or bridge returns or pedestal returns wider than 48".

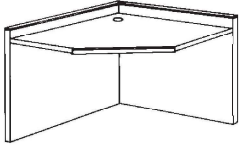

36x36x29	165	SCRS 3636
36x42x29	185	SCRS 3642A
42x36x29	185	SCRS 4236B
36x42x29	185	SCRS 3642C
42x36x29	185	SCRS 4236D
42x42x29	200	SCRS 4242
48x48x29	240	SCRS 4848

• *Corner grommet is standard*

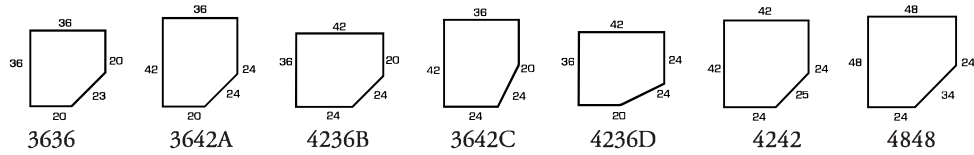

LEGS



20x1¼x29	40	SLEG 2029
24x1¼x29	45	SLEG 2429
30x1¼x29	50	SLEG 3029
36x1¼x29	55	SLEG 3629

SUPPORT PANELS

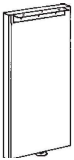

12x1¼x24¾	15	SSP 1224
15x1¼x24¾	20	SSP 1524

OPTIONS

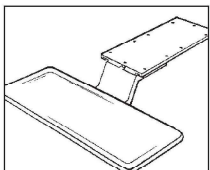

Slide-out Keyboard with Center Mount Slide and Molded Tray ZOK — \$

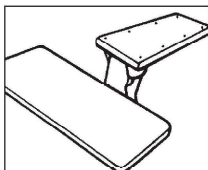

Articulating Keyboard with Molded Tray ART-M — \$

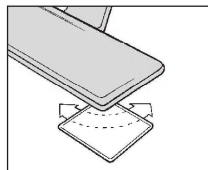

Mouse Pad Extension mounts to ZOK or ART-M MPE — \$

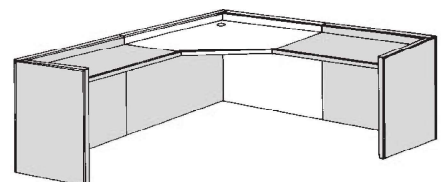

Size (WDH) Weight Model No. Price Features

COMPUTER TABLE / MACHINE STANDS

May be used alone or customized with options to meet specific applications (ex: add printer slot and paper shelf to make a printer stand, add casters and slide-out keyboard tray for mobile terminal table, etc.).

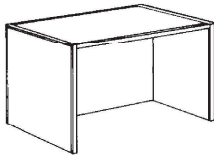

MACHINE HEIGHT UNITS

24x24x26	135	SSCT 2424
30x24x26	145	SSCT 3024
36x24x26	160	SSCT 3624
42x24x26	170	SSCT 4224
48x24x26	185	SSCT 4824
60x24x26	210	SSCT 6024
72x24x26	230	SSCT 7224

• Full modesty panel inset 1/2" from back

24x30x26	155	SSCT 2430
30x30x26	165	SSCT 3030
36x30x26	180	SSCT 3630
42x30x26	195	SSCT 4230
48x30x26	210	SSCT 4830
60x30x26	240	SSCT 6030
72x30x26	270	SSCT 7230

• Full modesty panel inset 6" from back

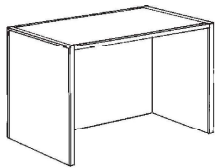

DESK HEIGHT UNITS

24x24x29	140	SSCE 2424
30x24x29	150	SSCE 3024
36x24x29	165	SSCE 3624
42x24x29	175	SSCE 4224
48x24x29	190	SSCE 4824
60x24x29	215	SSCE 6024
72x24x29	235	SSCE 7224

• Full modesty panel inset 1/2" from back

24x30x29	160	SSCE 2430
30x30x29	170	SSCE 3030
36x30x29	185	SSCE 3630
42x30x29	200	SSCE 4230
48x30x29	215	SSCE 4830
60x30x29	245	SSCE 6030
72x30x29	275	SSCE 7230

• Full modesty panel inset 6" from back

WOODSTOCK

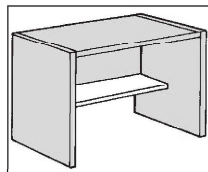

Paper Shelf — 12" d
up to 36" w PSU36 — \$
over 36" w PSO36 — \$

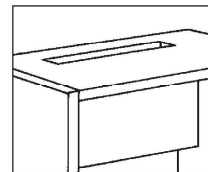

Printer Slot
P-Slot — \$

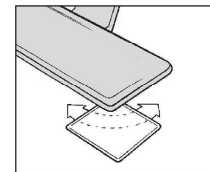

Mouse Pad Extension
mounts to ZOK or
ART-M MPE — \$

OPTIONS

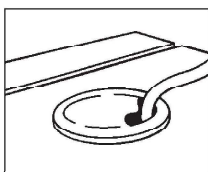

Grommet
FIGROM(x) — \$
indicate location

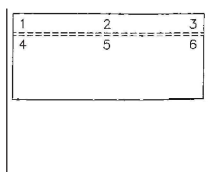

Grommet Locator

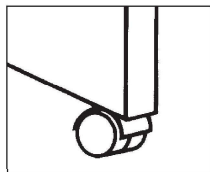

Casters (4)
CAST — \$

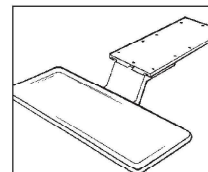

Slide-out Keyboard with
Center Mount Slide and
Molded Tray ZOK — \$

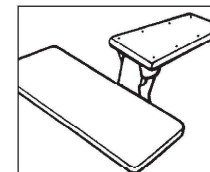

Articulating Keyboard
with Molded Tray
ART-M — \$

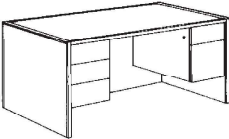
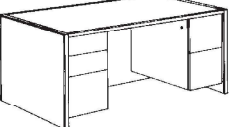
	Size (WDH)	Weight	Model No.	Price	Features
DOUBLE PEDESTAL DESKS					
	60x30x29	360	SDDP 6030		<ul style="list-style-type: none"> • Drop lock on box/file pedestal • 3 box left, box/file right • Full modesty panel recessed 6"
	66x30x29	380	SDDP 6630		
	72x30x29	390	SDDP 7230		
	72x36x29	415	SDDP 7236		
<hr/>					
	60x30x29	370	SCDP 6030		<ul style="list-style-type: none"> • Box/boxfile left, file/file right • Drop lock on file/file pedestal • Full modesty panel recessed 6"
	66x30x29	380	SCDP 6630		
	72x30x29	395	SCDP 7230		
	72x36x29	420	SCDP 7236		
<hr/>					

WOODSTOCK

OPTIONS

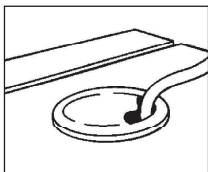

Grommet
FIGROM(x) — \$
indicate location

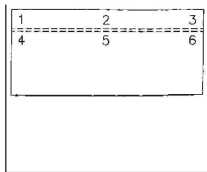

Grommet Locator

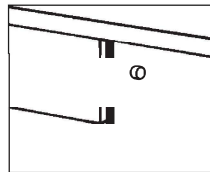

Pedestal Lock
D-LOCK — \$

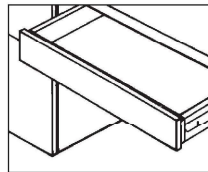

Pencil Drawer
PD — \$

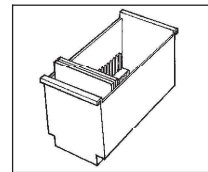

File Drawer Media Bin
holds 24 CD-ROM or
56 3½" Floppy Disks
MB — \$

C R E D E N Z A S

Size (WDH) Weight Model No. Price Features

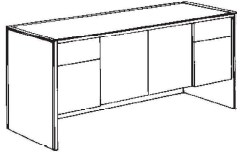

STORAGE CREDENZA

60x20x29	300	SDCC 6020
72x20x29	315	SDCC 7220
84x20x29	345	SDCC 8420

- 2 box, 2 file drawers
- Two door cabinet with adjustable shelf
- Lock on right hand pedestal

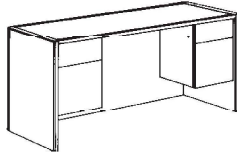

DOUBLE PEDESTAL CREDENZA

60x20x29	295	SDOC 6020
72x20x29	305	SDOC 7220
84x20x29	315	SDOC 8420

- 2 box, 2 file drawers
- Lock on right hand pedestal

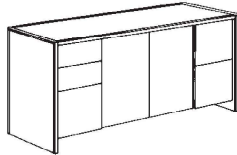

CUBE STYLE CREDENZA

60x20x29	340	SDSC 6020
72x20x29	370	SDSC 7220
84x20x29	400	SDSC 8420

- Box/box/file left, file/file right
- Two door cabinet with adjustable shelf
- Lock on right hand pedestal

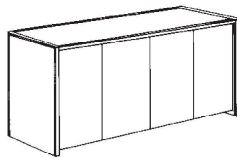

FOUR DOOR CREDENZAS

60x20x29	300	S4DC 6020
72x20x29	325	S4DC 7220
84x20x29	355	S4DC 8420

- Two interior sections
- One adjustable shelf per section

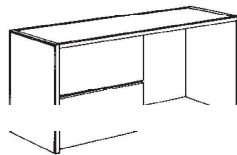

LATERAL FILE CREDENZA

60x20x29	350	SLOC 6020L
72x20x29	375	SLOC 7220L
84x20x29	400	SLOC 8420L

- Two 30" w lateral file drawers with lock
- 36" w lateral add \$100

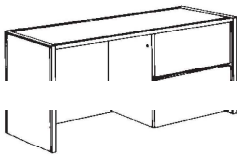

60x20x29	350	SLOC 6020R
72x20x29	375	SLOC 7220R
84x20x29	400	SLOC 8420R

- Two 30" w lateral file drawers with lock
- 36" w lateral add \$100

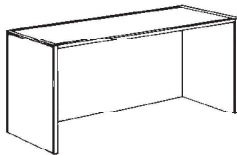

OPEN CREDENZA

60x20x29	205	SOOC 6020
72x20x29	225	SOOC 7220
84x20x29	245	SOOC 8420

- Add 18" d universal pedestals from page 76 to create custom single or double pedestal credenzas

OPTIONS

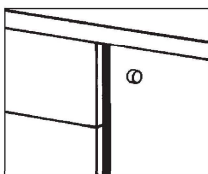



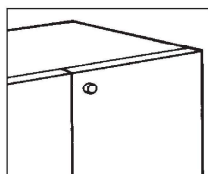

Pedestal Lock
D-LOCK — \$

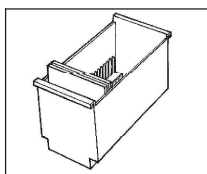

Door Lock
C-LOCK — \$

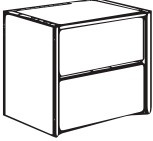

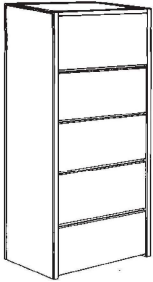
File Drawer Media Bin
holds 24 CD-ROM or
56 3½" Floppy Disks
MB — \$

	Size (WDH)	Weight	Model No.	Price	Features
LATERAL FILES					
	30x20x29	190	SLFC 3020		<ul style="list-style-type: none"> • Heavy-duty Accuride suspensions • Face-mounted gang lock specify F-LOCK2 — add \$
	36x20x29	210	SLFC 3620		
	42x20x29	230	SLFC 4220		
	30x20x43	245	SLF3 3020		<ul style="list-style-type: none"> • Anti-tip mechanism allows only one drawer open at a time • Face-mounted gang lock specify F-LOCK3 — add
	36x20x43	275	SLF3 3620		
	42x20x43	305	SLF3 4220		
	30x20x57	315	SLF4 3020		<ul style="list-style-type: none"> • Anti-tip mechanism allows only one drawer open at a time • Face-mounted gang lock specify F-LOCK4 — add \$
	36x20x57	345	SLF4 3620		
	42x20x57	375	SLF4 4220		
	30x20x72	385	SLF5 3020		<ul style="list-style-type: none"> • Four file drawers, flipper door top section • Anti-tip mechanism allows only one drawer open at a time • Face-mounted gang lock specify F-LOCK4 — add \$ • Cam lock for flipper door, C-Lock — add \$
	36x20x72	415	SLF5 3620		
	42x20x72	445	SLF5 4220		
	60x20x29	350	SLFC 6020		<ul style="list-style-type: none"> • Face-mounted gang lock(s) specify F-LOCK2 (L or R) — add \$per bank (two required to lock all drawers)
	72x20x29	370	SLFC 7220		

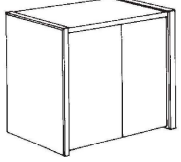
STORAGE CABINETS					
	30x20x29	180	SSTR 3020		<ul style="list-style-type: none"> • One adjustable shelf • Touch latch doors • Interior fully laminated
	36x20x29	200	SSTR 3620		
	42x20x29	220	SSTR 4220		

OPTIONS

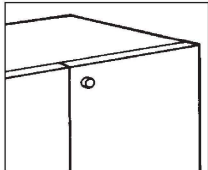

Door Lock
C-LOCK — \$

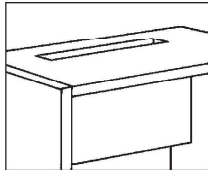

Printer Slot
P-Slot — \$

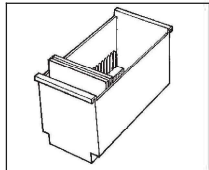

File Drawer Media Bin
holds 24 CD-ROM or
56 3½" Floppy Disks
MB — \$

WOODSTOCK

Size (WDH) Weight Model No. Price Features

PEDESTALS

MOBILE PEDESTALS

All drawer pedestals have fifth caster for stability.



16x18x20½	60	BFM 1618
16x22x20½	70	BFM 1622
16x28x20½	80	BFM 1628

- 1 box, 1 file drawer
- Box drawer includes pencil tray

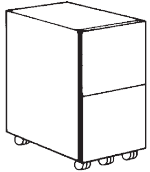

16x18x27	80	FFM 1618
16x22x27	90	FFM 1622
16x28x27	100	FFM 1628

- 2 file drawers

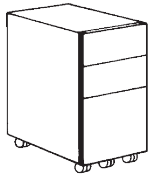

16x18x27	85	BBFM 1618
16x22x27	95	BBFM 1622
16x28x27	105	BBFM 1628

- 2 box, 1 file drawer
- Top box drawer includes pencil tray

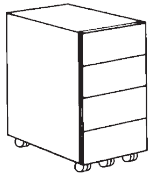

16x18x27	90	4BM 1618
16x22x27	100	4BM 1622
16x28x27	110	4BM 1628

- 4 box drawers
- Top box drawer includes pencil tray

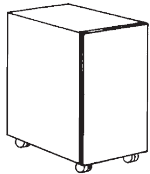

16x18x27	65	5DM 1618
16x22x27	75	5DM 1622
16x28x27	85	5DM 1628

- 1 door cabinet, hinged right
- Specify left hinge, if required
- One adjustable shelf

WOODSTOCK

OPTIONS

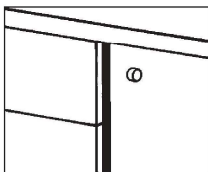

Pedestal Lock
D-LOCK — \$

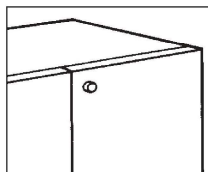

Door Lock
C-LOCK — \$

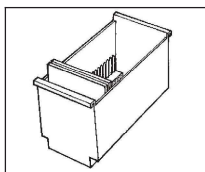

File Drawer Media Bin
holds 24 CD-ROM or
56 3½" Floppy Disks
MB — \$

Size (WDH) Weight Model No. Price Features

PEDESTALS

UNIVERSAL PEDESTALS

Sized to fit beneath desk height units, stand alone as free-standing units or remove 3" base to retrofit existing units or customize other pieces.

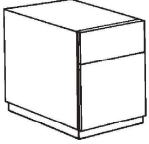

16x18x21 60 BFU 1618
 16x22x21 70 BFU 1622
 16x28x21 80 BFU 1628

- 1 box, 1 file drawer
- Box drawer includes pencil tray

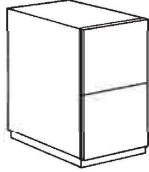

16x18x27½ 80 FFU 1618
 16x22x27½ 90 FFU 1622
 16x28x27½ 100 FFU 1628

- 2 file drawers



16x18x27½ 85 BBFU 1618
 16x22x27½ 95 BBFU 1622
 16x28x27½ 105 BBFU 1628

- 2 box, 1 file drawer
- Top box drawer includes pencil tray



16x18x27½ 90 4BU 1618
 16x22x27½ 100 4BU 1622
 16x28x27½ 110 4BU 1628

- 4 box drawers
- Top box drawer includes pencil tray



16x18x27½ 65 5DU 1618
 16x22x27½ 75 5DU 1622
 16x28x27½ 85 5DU 1628

- 1 door cabinet, hinged right
- Specify left hinge, if required
- One adjustable shelf

OPTIONS

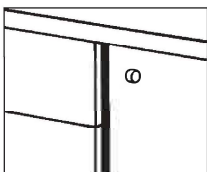

Pedestal Lock
D-LOCK — \$

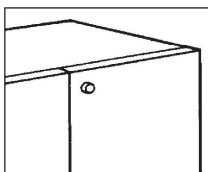

Door Lock
C-LOCK — \$

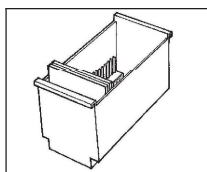

File Drawer Media Bin
holds 24 CD-ROM or
56 3½" Floppy Disks
MB — \$

Size (WDH) Weight Model No. Price Features

OVERSTORAGE COMPONENTS — WORKSURFACE MOUNTED

Attach to lower units with pass-thru clip/shoulder screw Mod-eze clip system. Metal-to-metal connection assures stability and ease of alignment.

FLIPPER DOOR UNITS

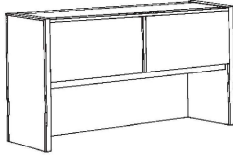

36x17x36	190	SFDU 3636
48x17x36	215	SFDU 4836
60x17x36	260	SFDU 6036
66x17x36	280	SFDU 6636
72x17x36	300	SFDU 7236
78x17x36	325	SFDU 7836
84x17x36	345	SFDU 8436

- 36" and 48" w units have one door, others have two
- Doors slide beneath top for safety and utility
- Accepts 21" tackable acoustically treated panel
- 18" clearance beneath valance

HINGED DOOR UNITS

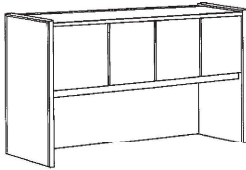

36x17x36	190	SHDU 3636
48x17x36	215	SHDU 4836
60x17x36	260	SHDU 6036
66x17x36	280	SHDU 6636
72x17x36	300	SHDU 7236
78x17x36	325	SHDU 7836
84x17x36	345	SHDU 8436

- 36" and 48" w units have three doors, others have four
- Accepts 21" tackable acoustically treated panel
- 18" clearance beneath valance

OPEN SHELF UNITS

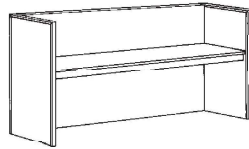

36x17x30	150	SSHU 3630
48x17x30	170	SSHU 4830
60x17x30	185	SSHU 6030
66x17x30	205	SSHU 6630
72x17x30	220	SSHU 7230
78x17x30	240	SSHU 7830
84x17x30	255	SSHU 8430

- Accepts 21" tackable acoustically treated panel
- 18" clearance beneath valance

870

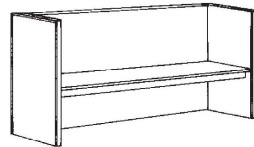

36x17x36	160	SSHU 3636
48x17x36	180	SSHU 4836
60x17x36	205	SSHU 6036
66x17x36	225	SSHU 6636
72x17x36	245	SSHU 7236
78x17x36	265	SSHU 7836
84x17x36	285	SSHU 8436

- Accepts 21" tackable acoustically treated panel
- 18" clearance beneath valance

See page 78 for tackable panels.

WOODSTOCK

OPTIONS

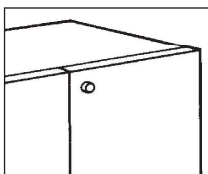

Door Lock
C-LOCK — \$

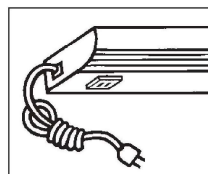

Task Light
LITE0024 24" w — \$
LITE0048 48" w — \$

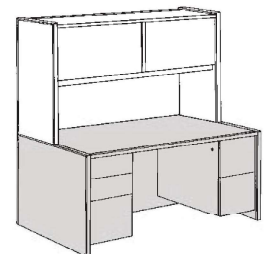
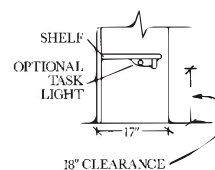

Size (WDH) Weight Model No. Price Features

OVERSTORAGE UNITS – WALLMOUNT

All units have recessed back with concealed wood cleat wall mount strip.

Note: Wall conditions encountered in field vary greatly. The installer should verify that wall conditions and hardware utilized are sufficient to carry weight of loaded cabinet.

All units have 2½" h fascia strip to conceal optional task light.

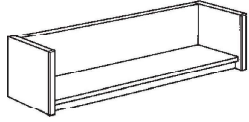

BUCKET SHELF UNITS WITH WOODSTOCK TRIM

36x17x16	50	SWMO 3617
42x17x16	55	SWMO 4217
48x17x16	60	SWMO 4817
60x17x16	70	SWMO 6017
66x17x16	75	SWMO 6617
72x17x16	80	SWMO 7217

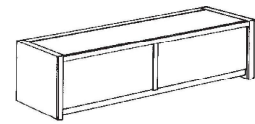

FLIPPER DOOR UNITS WITH WOODSTOCK TRIM

36x17x16	60	SWFD 3617
42x17x16	65	SWFD 4217
48x17x16	70	SWFD 4817
60x17x16	80	SWFD 6017
66x17x16	85	SWFD 6617
72x17x16	90	SWFD 7217

• 36", 42", 48" w units have one door, others have two

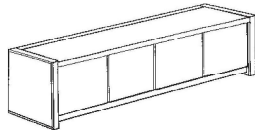

HINGE DOOR UNITS WITH WOODSTOCK TRIM

36x17x16	60	SWHD 3617
42x17x16	65	SWHD 4217
48x17x16	70	SWHD 4817
60x17x16	80	SWHD 6017
66x17x16	85	SWHD 6617
72x17x16	90	SWHD 7217

• 36", 42", 48" w units have three doors, others have four

TACKABLE PANELS



33½ x ¾ x 21	5	TACK 3421
45½ x ¾ x 21	5	TACK 4621
57½ x ¾ x 21	10	TACK 5821
63½ x ¾ x 21	10	TACK 6421
69½ x ¾ x 21	15	TACK 7021
75½ x ¾ x 21	15	TACK 7621
81½ x ¾ x 21	15	TACK 8221

• Use with overstorage units for tackability, acoustical effect
• Available in Guilford 701 Series, Pattern 2100

OPTIONS

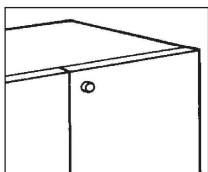

Door Lock
C-LOCK — \$

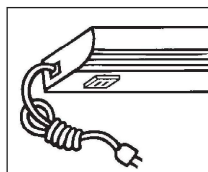

Task Light
LITE0024 24" w — \$
LITE0048 48" w — \$

Size (WDH) Weight Model No. Price COM*

S C R E E N S

Screens may be combined with any of the modular casegood items in the Woodstock Series to provide visual and acoustical privacy. Screens mount easily into end panels and worksurfaces with a heavy duty steel post mechanism. They may be readily removed to provide conferencing capabilities. Pricing is based on Guilford 701 Series fabrics, Pattern 2100. *Note:* For in-between sizes, use next largest size for pricing.



15" HIGH SCREENS

20x1¼x15	9	SCRN 2015	½ yd
24x1¼x15	10	SCRN 2415	½ yd
30x1¼x15	13	SCRN 3015	½ yd
36x1¼x15	15	SCRN 3615	1 yd
42x1¼x15	18	SCRN 4215	1 yd
48x1¼x15	20	SCRN 4815	1 yd
54x1¼x15	23	SCRN 5415	1 yd
60x1¼x15	25	SCRN 6015	1 yd
66x1¼x15	28	SCRN 6615	2 yd
72x1¼x15	30	SCRN 7215	2¼ yd

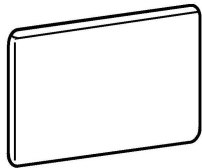

22" HIGH SCREENS

20x1¼x22	13	SCRN 2022	¾ yd
24x1¼x22	15	SCRN 2422	¾ yd
30x1¼x22	19	SCRN 3022	¾ yd
36x1¼x22	22	SCRN 3622	1½ yd
42x1¼x22	26	SCRN 4222	1½ yd
48x1¼x22	30	SCRN 4822	1½ yd
54x1¼x22	33	SCRN 5422	1½ yd
60x1¼x22	37	SCRN 6022	1½ yd
66x1¼x22	41	SCRN 6622	2 yd
72x1¼x22	44	SCRN 7222	2¼ yd

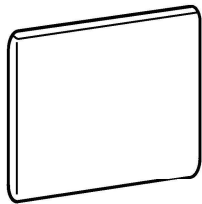

36" HIGH SCREENS

20x1¼x36	20	SCRN 2036	1¼ yd
24x1¼x36	24	SCRN 2436	1¼ yd
30x1¼x36	30	SCRN 3036	1¼ yd
36x1¼x36	36	SCRN 3636	2¼ yd
42x1¼x36	42	SCRN 4236	2¼ yd
48x1¼x36	48	SCRN 4836	2¼ yd
54x1¼x36	54	SCRN 5436	2¼ yd
60x1¼x36	60	SCRN 6036	2¼ yd
66x1¼x36	66	SCRN 6636	4¼ yd
72x1¼x36	72	SCRN 7236	4½ yd

*COM yardage based on 66" w, non-directional fabric. COM material must be approved by HLF before an order can be accepted. All COM material must be shipped to HLF prepaid.

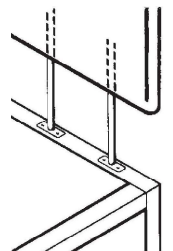
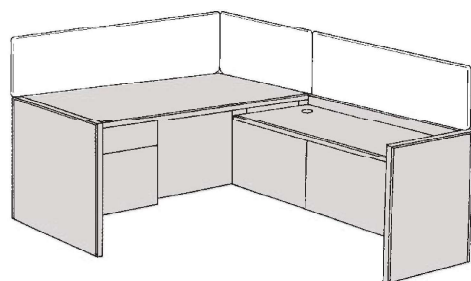

Size (WDH) Weight Model No. Price Features

RECEPTION STATIONS

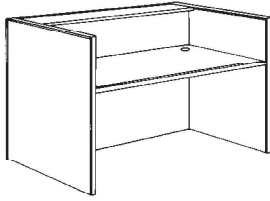

DESK SHELLS WITH 6" RECESSED FACE PANEL

60x30x42	265	SRED 6030
66x30x42	295	SRED 6630
72x30x42	325	SRED 7230
72x36x42	365	SRED 7236

- 10" d transaction ledge
- 29" AFF worksurface
- Grommet each side
- Unhanded — accepts left or right return
- 30" d units accept 22" d pedestals — see p. 76
- 36" d units accept 28" d pedestals — see p. 76

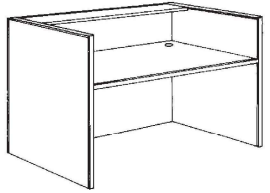

DESK SHELLS WITH 1/4" RECESSED FACE PANEL

60x30x42	285	SFED 6030
66x30x42	315	SFED 6630
72x30x42	345	SFED 7230
72x36x42	385	SFED 7236

- 10" d transaction ledge
- 29" AFF worksurface
- Grommet each side
- Unhanded — accepts left or right return
- Accept 28" d pedestals — see p. 76

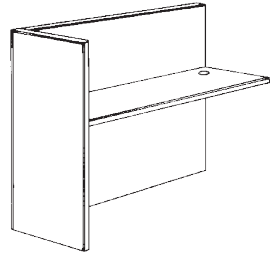

RETURNS—LEFT HAND

36x20x42	150	SROL 3620
42x20x42	160	SROL 4220
48x20x42	170	SROL 4820
60x20x42	200	SROL 6020
36x24x42	160	SROL 3624
42x24x42	170	SROL 4224
48x24x42	180	SROL 4824
60x24x42	210	SROL 6024

- 29" AFF worksurface
- Grommet
- Accepts 18" d pedestal — see p. 76

- Accepts 22" d pedestal — see p. 76

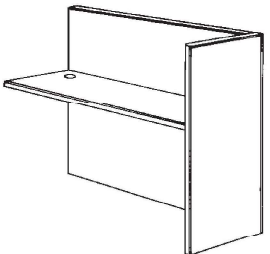

RETURNS—RIGHT HAND

36x20x42	150	SROR 3620
42x20x42	160	SROR 4220
48x20x42	170	SROR 4820
60x20x42	200	SROR 6020
36x24x42	160	SROR 3624
42x24x42	170	SROR 4224
48x24x42	180	SROR 4824
60x24x42	210	SROR 6024

- 29" AFF worksurface
- Grommet
- Accepts 18" d pedestal — see p. 76

- Accepts 22" d pedestal — see p. 76

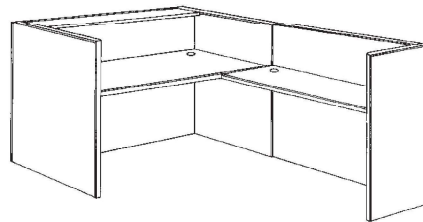
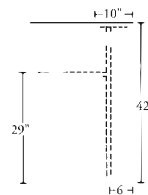

OPTIONS

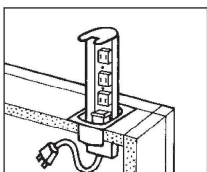

Electrified Grommet
RPCGROM — \$

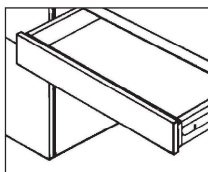

Pencil Drawer
PD — \$

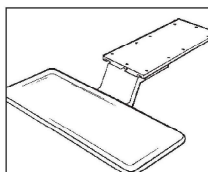

Slide-out Keyboard with
Center Mount Slide and
Molded Tray
ZOK — \$

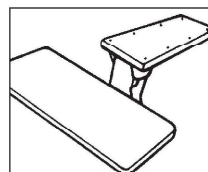

Articulating Keyboard
with Molded Tray
ART-M — \$

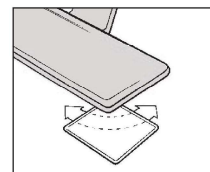

Mouse Pad Extension
mounts to ZOK or
ART-M MPE — \$

RECEPTION DESKS:

GENERAL SERIES FEATURES

- All top surfaces and end panels are high pressure plastic laminate over 1 1/8" thick 45 lb. density industrial grade particle board.
- Vertical surfaces are high pressure plastic laminate over 1 1/8" or 5/8" industrial grade particle board on flat areas or over 1/8" birch, luaun or hardboard supported by wood-strut framing on rounded areas.
- Leveling glides are supplied on all units.

Note: Because of their size and configuration multiple piece reception stations are hand-fitted. As such, dimensions vary slightly from piece to piece and adding or changing pieces later may result in some irregularities.

TABLE OF CONTENTS

ITEM	PAGE
Curved reception desk with railing.....	82
Half circle reception desk.....	83
Half circle reception desk with railing.....	84
Half circle reception desk with stepped rail.....	85
Reception return pedestals.....	86
Radius hi-profile reception desk.....	87
Hi-profile reception desk.....	88

Size (WDH) Weight Model No. Price Features

CURVED RECEPTION DESK WITH RAILING

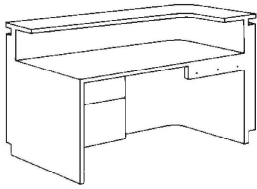

RIGHT RETURN DESK

72x30x36	300	200R 7236
72x30x42	350	200R 7242
84x30x36	350	200R 8436
84x30x42	400	200R 8442
96x30x36	400	200R 9636
96x30x42	450	200R 9642

- Accepts right hand return
- 1 box, 1 file drawer
- Drop lock included
- *Reveal and base may be finished in bright or brushed chrome or brass or plastic laminate*

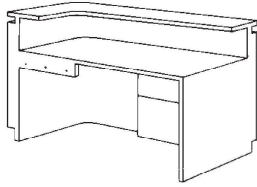

LEFT RETURN DESK

72x30x36	300	200L 7236
72x30x42	350	200L 7242
84x30x36	350	200L 8436
84x30x42	400	200L 8442
96x30x36	400	200L 9636
96x30x42	450	200L 9642

- Accepts left hand return
- 1 box, 1 file drawer
- Drop lock included
- *Reveal and base may be finished in bright or brushed chrome or brass or plastic laminate*

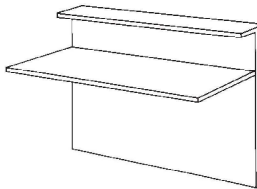

CENTER EXTENSION—NOT FREE-STANDING

36x30x36	125	200C 3636
48x30x36	140	200C 4836
60x30x36	170	200C 6036
36x30x42	135	200C 3642
48x30x42	155	200C 4842
60x30x42	190	200C 6042

- Unhanded
- *Reveal and base may be finished in bright or brushed chrome or brass or plastic laminate*
- *Worksurface 29" AFF*

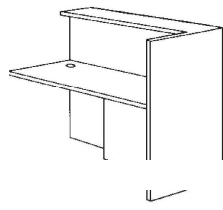

RIGHT HAND RETURN

42x30x36	145	201R 4236
48x30x36	160	201R 4836
60x30x36	190	201R 6036
42x30x42	155	201R 4242
48x30x42	175	201R 4842
60x30x42	210	201R 6042

- Stationery cabinet with shelves
- *Worksurface 29" AFF*
- Grommet

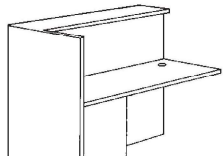

LEFT HAND RETURN

42x30x36	145	201L 4236
48x30x36	160	201L 4836
60x30x36	190	201L 6036
42x30x42	155	201L 4242
48x30x42	175	201L 4842
60x30x42	210	201L 6042

- Stationery cabinet with shelves
- *Worksurface 29" AFF*
- Grommet

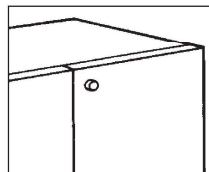

Door Lock
C-LOCK — \$

OPTIONS

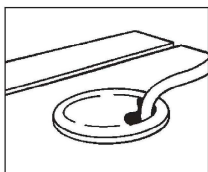

Grommet
FIGROM(x) — \$
indicate location

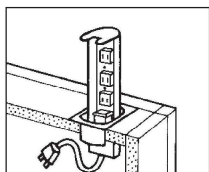

Electrified Grommet
RPCGROM — \$

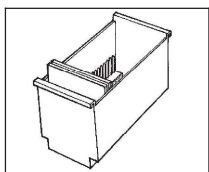

File Drawer Media Bin
holds 24 CD-ROM or
56 3½" Floppy Disks
MB — \$

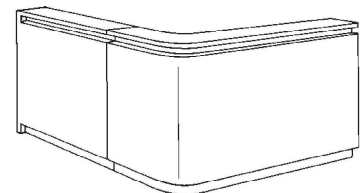
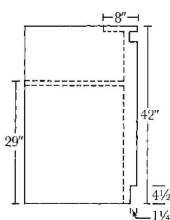

Size (WDH)	Weight	Model No.	Price	Features
------------	--------	-----------	-------	----------

HALF CIRCLE RECEPTION DESK

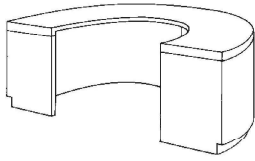

HALF CIRCLE DESK

96x48x29	350	400C 9648
----------	-----	-----------

- 48" outside radius
- 24" inside radius
- Chrome, brass or black accents and kick, specify
- Ships KD (3 pieces)

QUARTER CIRCLE EXTENSION

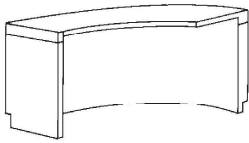

48x48x29	175	410L 4848
48x48x29	175	410R 4848
48x48x29	175	410U 4848

- 410L indicates left extension (as pictured)
- 410R indicates right extension
- 410U indicates unhandled extension (no end panel)
- 48" outside radius
- 24" inside radius
- Chrome, brass or black accents and kick, specify
- Ships KD (2 pieces)

CENTER EXTENSION—NOT FREE STANDING

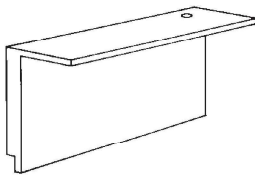

36x24x29	90	400B 3624
42x24x29	100	400B 4224
48x24x29	110	400B 4824
60x24x29	130	400B 6024
72x24x29	150	400B 7224

- Worksurface 29" AFF
- Ships set-up
- One grommet standard

LEFT HAND RETURN

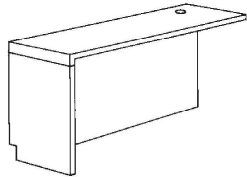

42x24x29	100	401L 4224
48x24x29	115	401L 4824
60x24x29	140	401L 6024

- Worksurface 29" AFF
- Ships set-up
- One grommet standard

RIGHT HAND RETURN

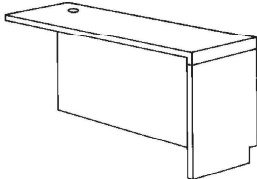

42x24x29	100	401R 4224
48x24x29	115	401R 4824
60x24x29	140	401R 6024

- Worksurface 29" AFF
- Ships set-up
- One grommet standard

Refer to p. 86 for built in pedestal options.
Or specify mobile or universal pedestals from Basics or Express Series.

OPTIONS

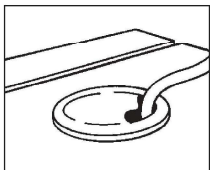

Grommet
FIGROM(x) — \$
indicate location

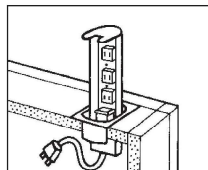

Electrified Grommet
RPCGROM — \$

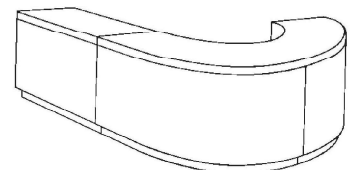
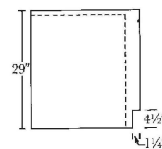

Size (WDH) Weight Model No. Price Features

HALF CIRCLE RECEPTION DESK WITH RAILING

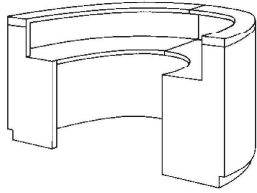

HALF CIRCLE DESK WITH RAILING
 96x48x42 400 500C 9648

- 48" outside radius
- 24" inside radius
- Chrome, brass or black accents and kick, specify
- Ships in two quarter circle pieces

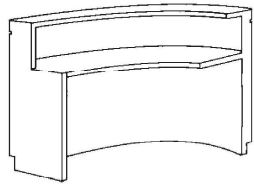

QUARTER CIRCLE EXTENSION
 48x48x42 220 510L 4848
 48x48x42 220 510R 4848
 48x48x42 220 510U 4848

- 510L indicates left extension (as pictured)
- 510R indicates right extension
- 510U indicates unhandled extension (no end panel)
- 48" outside radius
- 24" inside radius
- Chrome, brass or black accents and kick, specify
- Ships set-up

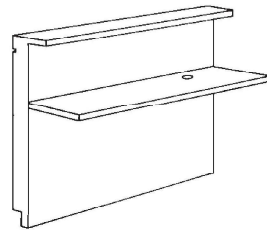

CENTER EXTENSION—NOT FREE STANDING
 36x24x42 90 500B 3624
 42x24x42 100 500B 4224
 48x24x42 110 500B 4824
 60x24x42 130 500B 6024
 72x24x42 150 500B 7224

- Worksurface 29" AFF
- Ships set-up
- One grommet standard

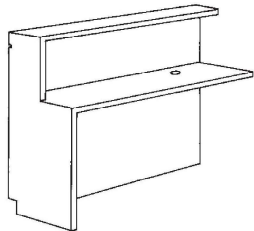

LEFT HAND RETURN
 42x24x42 140 501L 4224
 48x24x42 160 501L 4824
 60x24x42 200 501L 6024

- Worksurface 29" AFF
- Ships set-up
- One grommet standard

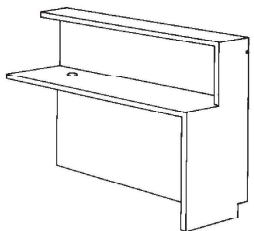

RIGHT HAND RETURN
 42x24x42 140 501R 4224
 48x24x42 160 501R 4824
 60x24x42 200 501R 6024

- Worksurface 29" AFF
- Ships set-up
- One grommet standard

Refer to p. 86 for built in pedestal options. Or specify mobile or universal pedestals from Basics or Express Series.

OPTIONS

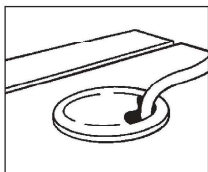

Grommet
 FIGROM(x) — \$
 indicate location

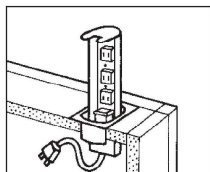

Electrified Grommet
 RPCGROM — \$

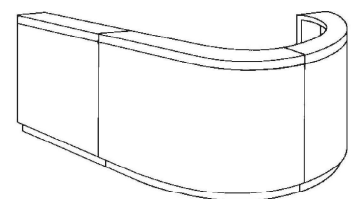
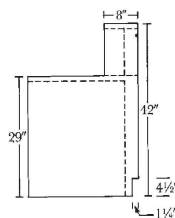

RECEPTION DESKS

Size (WDH)	Weight	Model No.	Price	Features
------------	--------	-----------	-------	----------

HALF CIRCLE RECEPTION DESK WITH STEPPED RAIL

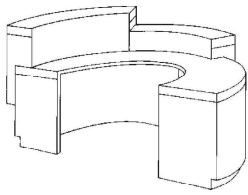

HALF CIRCLE DESK WITH STEP—LEFT
96x48x42 400 600L 9648

- 48" outside radius
- 24" inside radius
- 29" AFF worksurface
- Chrome, brass or black accents and kick, specify
- Ships KD (5 pieces)

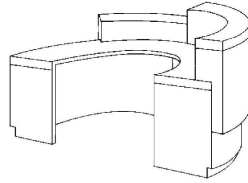

HALF CIRCLE DESK WITH STEP—RIGHT
96x48x42 400 600R 9648

- 48" outside radius
- 24" inside radius
- 29" AFF worksurface
- Chrome, brass or black accents and kick, specify
- Ships KD (5 pieces)

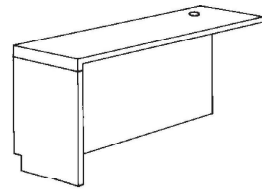

LEFT HAND RETURN—DESK HEIGHT
42x24x29 100 601L 4224
48x24x29 115 601L 4824
60x24x29 140 601L 6024

- Worksurface 29" AFF
- Ships set-up
- One grommet standard

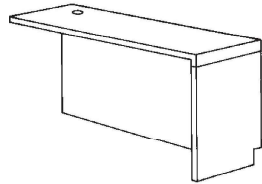

RIGHT HAND RETURN—DESK HEIGHT
42x24x29 100 601R 4224
48x24x29 115 601R 4824
60x24x29 140 601R 6024

- Worksurface 29" AFF
- Ships set-up
- One grommet standard

Refer to p. 86 for built in pedestal options.
Or specify mobile or universal pedestals from Basics or Express Series.

OPTIONS

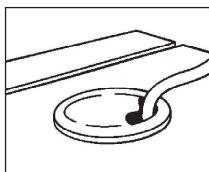

Grommet
FIGROM(x) — \$
indicate location

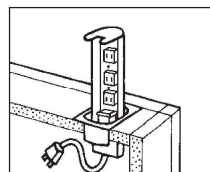

Electrified Grommet
RPCGROM — \$

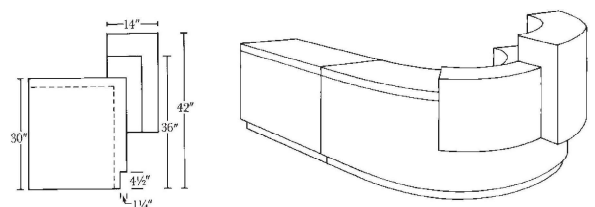

	Size (WDH)	Weight	Model No.	Price	Features
RECEPTION RETURN PEDESTALS					
	16x18x18½	45	BFR 1618		<ul style="list-style-type: none"> • 1 box, 1 file drawer • Pencil tray in top drawer
	16x18x24½	30	5DR 1618		<ul style="list-style-type: none"> • Stationery cabinet with shelves
	16x18x24½	55	BBFR 1618		<ul style="list-style-type: none"> • 2 box, 1 file drawer • Pencil tray in top drawer
	16x18x24½	50	FFR 1618		<ul style="list-style-type: none"> • 2 file drawers

Note: Each of these pedestals can be used with all half-circle reception desks and accompanying returns. Please specify desired location. For mobile pedestal selection, refer to Basics Series or Express Series.

OPTIONS

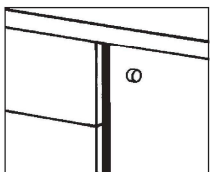

Pedestal Lock
D-LOCK — \$

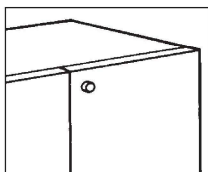

Door Lock
C-LOCK — \$

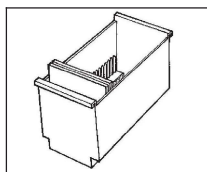

File Drawer Media Bin
holds 24 CD-ROM or
56 3½" Floppy Disks
MB — \$

Size (WDH) Weight Model No. Price Features

RADIUS HI-PROFILE RECEPTION DESK

RADIUS HI-PROFILE DESK

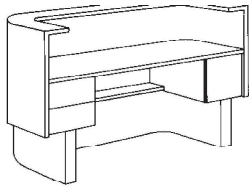

72x30x36	300	700C 7236
84x30x36	325	700C 8436
72x30x42	330	700C 7242
84x30x42	355	700C 8442

- Specify bright or brushed chrome or brass or plastic laminate finish on base
- Two box left, one file right
- Pedestal eliminated where return used
- Worksurface 29" AFF

LEFT HAND RETURN

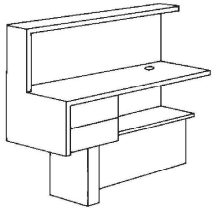

42x24x36	120	701L 4236
48x24x36	140	701L 4836
60x24x36	175	701L 6036
42x24x42	140	701L 4242
48x24x42	160	701L 4842
60x24x42	195	701L 6042

- Worksurface 29" AFF
- Two box drawers
- One grommet standard

RIGHT HAND RETURN

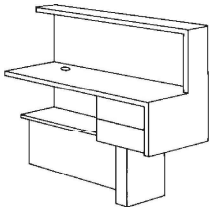

42x24x36	120	701R 4236
48x24x36	140	701R 4836
60x24x36	175	701R 6036
42x24x42	140	701R 4242
48x24x42	160	701R 4842
60x24x42	195	701R 6042

- Worksurface 29" AFF
- Two box drawers
- One grommet standard

OPTIONS

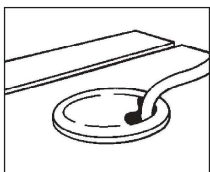

Grommet
FIGROM(x) — \$
indicate location

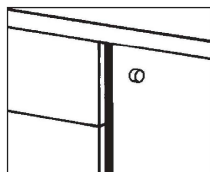

Pedestal Lock
D-LOCK — \$

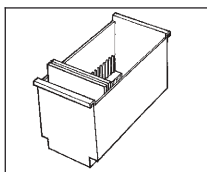

File Drawer Media Bin
holds 24 CD-ROM or
56 3½" Floppy Disks
MB — \$

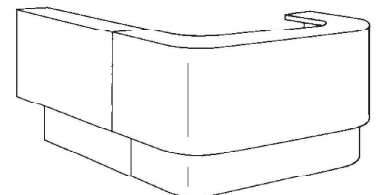
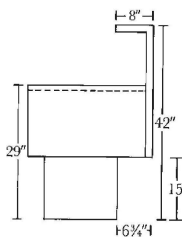

Size (WDH) Weight Model No. Price Features

HI-PROFILE RECEPTION DESK

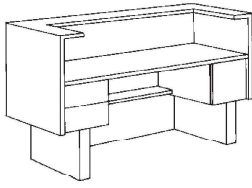

HI-PROFILE DESK

72x30x36	300	800C 7236
84x30x36	325	800C 8436
96x30x36	350	800C 9636
72x30x42	330	800C 7242
84x30x42	355	800C 8442
96x30x42	380	800C 9642

- Specify bright or brushed chrome or brass or plastic laminate finish on base
- Two box left, one file right
- Pedestal eliminated where return used
- Worksurface 29" AFF

LEFT HAND RETURN

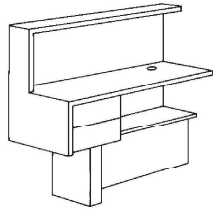

42x24x36	120	801L 4236
48x24x36	140	801L 4836
60x24x36	175	801L 6036
42x24x42	140	801L 4242
48x24x42	160	801L 4842
60x24x42	195	801L 6042

- Worksurface 29" AFF
- Two box drawers
- One grommet standard

RIGHT HAND RETURN

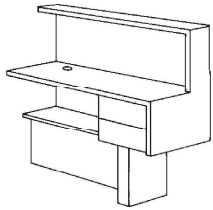

42x24x36	120	801R 4236
48x24x36	140	801R 4836
60x24x36	175	801R 6036
42x24x42	140	801R 4242
48x24x42	160	801R 4842
60x24x42	195	801R 6042

- Worksurface 29" AFF
- Two box drawers
- One grommet standard

OPTIONS

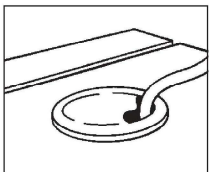

Grommet
FIGROM(x) — \$
indicate location

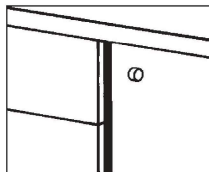

Pedestal Lock
D-LOCK — \$

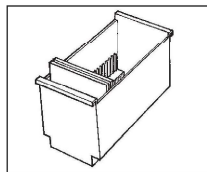

File Drawer Media Bin
holds 24 CD-ROM or
56 3½" Floppy Disks
MB — \$

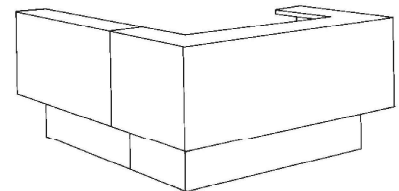
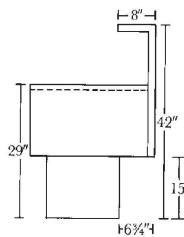

BOOKCASES, STORAGE, WALL UNITS, CARRELS:

TABLE OF CONTENTS

ITEM	PAGE
Bookcases	90–91
Carrel Accessories	97
Commercial Cabinetry	98–99
Storage Cabinets	92
Study Carrels	99
Wall Units.	93–94
Wall Unit Options	95
Wardrobe Units/Storage Cabinets.	96

Size (WDH) Weight Model No. Price Number of Shelves

BOOKCASES

- Bookcases are available in both the Standard Series, which features high pressure laminate over 5/8" particle board, and the budgetworthy Basics Series, which is constructed of 3/4" thermally fused melamine clad panels.
- While Standard Series Bookcases are available in any of our standard finishes as well as many non-standard finishes, please note that Basics Series Bookcases are available ONLY in our Basics finishes.
- Number of shelves includes fixed top and bottom.
- Units 60"h or over have fixed shelf 30" AFF.
- When ordering specify model number and edge type (i.e., STSB 3029 (175)).

$\frac{3}{4}$ " $\frac{3}{4}$ "
Self edge Hardwood
175 675

STANDARD SERIES

All units clad in high pressure plastic laminate over 5/8" industrial particle board.
 Hardwood edges available in oak or mahogany — specify.



30x12x29	60	STSB 3029	3
30x12x42	81	STSB 3042	4
30x12x48	87	STSB 3048	4
30x12x60	106	STSB 3060	5
30x12x78	138	STSB 3078	6

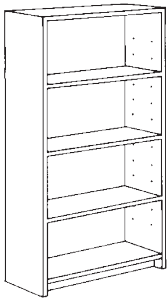

36x12x29	69	STSB 3629	3
36x12x42	93	STSB 3642	4
36x12x48	99	STSB 3648	4
36x12x60	123	STSB 3660	5
36x12x78	156	STSB 3678	6

STANDARD WIDE SERIES

All units clad in high pressure plastic laminate over 5/8" industrial particle board.
 Wide Series Bookcases feature a fixed center divider for maximum load capacity.
 Number of shelves indicates shelves per side including fixed top and bottom.
 Hardwood edges available in oak or mahogany — specify.

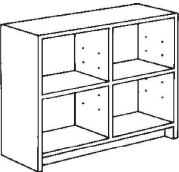

42x12x29	87	WDSB 4229	3
42x12x42	117	WDSB 4242	4
42x12x48	123	WDSB 4248	4
42x12x60	156	WDSB 4260	5
42x12x78	195	WDSB 4278	6

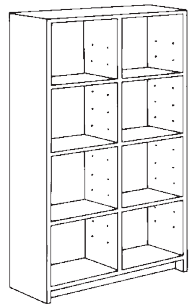

48x12x29	90	WDSB 4829	3
48x12x42	123	WDSB 4842	4
48x12x48	135	WDSB 4848	4
48x12x60	168	WDSB 4860	5
48x12x78	213	WDSB 4878	6

Size (WDH) Weight Model No. Price Number of Shelves

BOOKCASES

- Number of shelves includes fixed top and bottom.
- Units 60" h or over have fixed shelf 30" AFF.
- When ordering specify model number and edge type (i.e., STSB 3029 (175)).

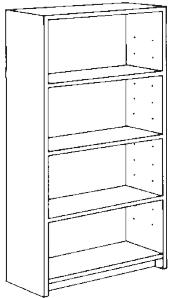

**3/4"
Self edge
175**

BASICS SERIES

All units constructed of 3/4" thermally fused melamine clad panels. Available in Basics finishes ONLY. Self edge only.

30x12x29	60	MTSB 3029	3
30x12x42	81	MTSB 3042	4
30x12x48	87	MTSB 3048	4
30x12x60	106	MTSB 3060	5
30x12x78	138	MTSB 3078	6
<hr/>			
36x12x29	69	MTSB 3629	3
36x12x42	93	MTSB 3642	4
36x12x48	99	MTSB 3648	4
36x12x60	123	MTSB 3660	5
36x12x78	156	MTSB 3678	6

BASICS WIDE SERIES

All units constructed of 3/4" thermally fused melamine clad panels. Available in Basics finishes ONLY. Self edge only. Wide Series Bookcases feature a fixed center divider for maximum load capacity. Number of shelves indicates shelves per side including fixed top and bottom.

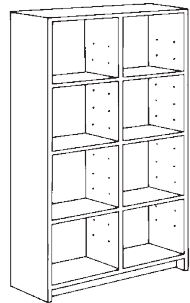
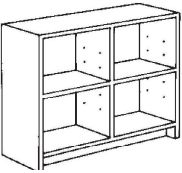

42x12x29	87	MDSB 4229	3
42x12x42	117	MDSB 4242	4
42x12x48	123	MDSB 4248	4
42x12x60	156	MDSB 4260	5
42x12x78	195	MDSB 4278	6
<hr/>			
48x12x29	90	MDSB 4829	3
48x12x42	123	MDSB 4842	4
48x12x48	135	MDSB 4848	4
48x12x60	168	MDSB 4860	5
48x12x78	213	MDSB 4878	6

**Size (WDH) Weight Model No. Price Price per
Additional Shelf**

STORAGE CABINETS

**3/4"
Self edge
175**

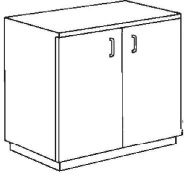

TWO DOOR CABINET

Pulls are 128mm black crescent.
One adjustable shelf.
Additional shelves — AASH, see RH column.

24x18x29	65	S1SC 2418
30x18x29	85	S1SC 3018
36x18x29	95	S1SC 3618
42x18x29	105	S1SC 4218
24x24x29	83	S1SC 2424
30x24x29	106	S1SC 3024
36x24x29	119	S1SC 3624
42x24x29	133	S1SC 4224

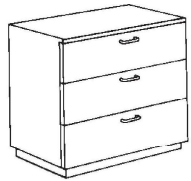

THREE DRAWER CABINET

Drawers are solid wood fully laminated with white vinyl.
Pulls are 128mm black crescent.

24x18x29	87	S2SC 2418
30x18x29	110	S2SC 3018
36x18x29	125	S2SC 3618
42x18x29	138	S2SC 4218
24x24x29	108	S2SC 2424
30x24x29	140	S2SC 3024
36x24x29	155	S2SC 3624
42x24x29	173	S2SC 4224

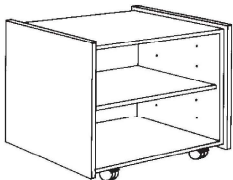

CART

30x18x36	145	S1TC 3036
36x18x36	160	S1TC 3636
42x18x36	180	S1TC 4236

Size (WDH) Weight Model No. Price

WALL UNITS

- Fully modular units which may be used individually or combined to form an entire wall or space divider.
- All units fully laminated with high pressure plastic laminate over 5/8" industrial particle board.
- Drawers are solid wood fully laminated with white vinyl.
- Accuride® suspensions on all drawers.
- Blum® hinges on all doors.
- Unit backs are fully laminated.
- Pulls are 128mm black crescent.
- Custom configurations and sizes available — consult factory for details and pricing.
- Specify model number and edge treatment (i.e., BSUC 3620 (175)).

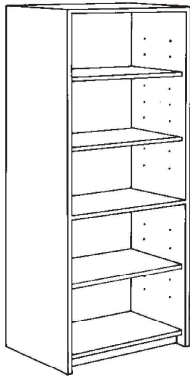

SHELF UNIT

^{3/4"} ^{3/4"}
Self edge Hardwood
175 675

Fixed shelf at 30" AFF. One adjustable shelf in lower section. Two adjustable shelves in upper section. Adjustable leveling glides.

24x20x78	168	BSUC 2420
30x20x78	192	BSUC 3020
36x20x78	219	BSUC 3620
24x24x78	189	BSUC 2424
30x24x78	219	BSUC 3024
36x24x78	246	BSUC 3624

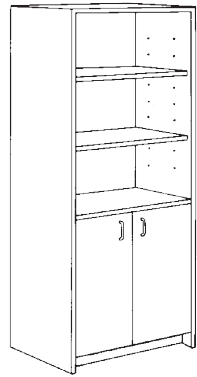

SHELF UNIT WITH LOWER DOORS

Two door lower cabinet with adjustable shelf. Two adjustable shelves in upper section. Adjustable leveling glides.

24x20x78	180	BSLD 2420
30x20x78	207	BSLD 3020
36x20x78	237	BSLD 3620
24x24x78	201	BSLD 2424
30x24x78	234	BSLD 3024
36x24x78	264	BSLD 3624

Size (WDH) Weight Model No. Price

WALL UNITS

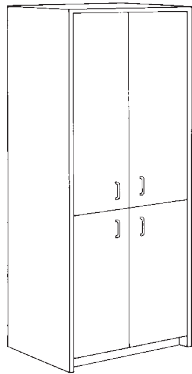

SHELF UNIT WITH LOWER DOORS AND FULL UPPER DOORS

^{3/4"}
Self edge 175 ^{3/4"}
Hardwood 675

Two door lower cabinet with adjustable shelf. Two door upper cabinet with two adjustable shelves. Adjustable leveling glides.

24x20x78	204	BLUD 2420
30x20x78	237	BLUD 3020
36x20x78	273	BLUD 3620

24x24x78	225	BLUD 2424
30x24x78	264	BLUD 3024
36x24x78	299	BLUD 3624

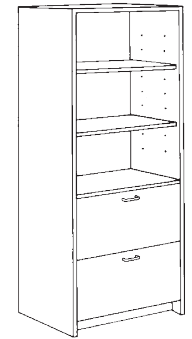

SHELF UNIT WITH LATERAL FILE DRAWERS

Two lateral file drawers in lower section equipped for both letter and legal size hanging file folders. Two adjustable shelves in upper section. Adjustable leveling glides.

24x20x78	225	BLFC 2420
30x20x78	252	BLFC 3020
36x20x78	282	BLFC 3620

24x24x78	246	BLFC 2424
30x24x78	279	BLFC 3024
36x24x78	309	BLFC 3624

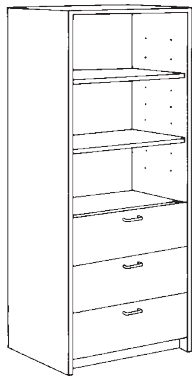

SHELF UNIT WITH THREE BOX DRAWERS

Three box drawers in lower section. Two adjustable shelves in upper section. Adjustable leveling glides.

24x20x78	230	BTBD 2420
30x20x78	257	BTBD 3020
36x20x78	287	BTBD 3620

24x24x78	251	BTBD 2424
30x24x78	284	BTBD 3024
36x24x78	314	BTBD 3624

Size (WDH) Weight Model No. Price

WALL UNIT OPTIONS



UPPER CABINET

Two door upper cabinet section 18" h installed in any shelf unit.

24w	10	ATDU 2418
30w	12	ATDU 3018
36w	15	ATDU 3618

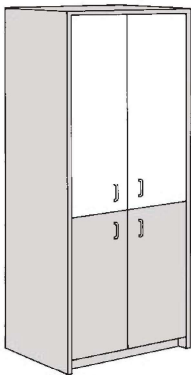

FULL UPPER DOORS

Two full height doors installed in any shelf unit.

24w	24	AFDU 2418
30w	30	AFDU 3018
36w	36	AFDU 3618



ADDITIONAL SHELVES

Includes adjustable shelf hardware. Use AASH xx18 with 20" d shelf units; use AASH xx22 with 24" units.

24x18x ³ / ₄	10	AASH 2418
30x18x ³ / ₄	12	AASH 3018
36x18x ³ / ₄	14	AASH 3618

24x22x ³ / ₄	12	AASH 2422
30x22x ³ / ₄	15	AASH 3022
36x22x ³ / ₄	18	AASH 3622

Size (WDH) Weight Model No. Price

WARDROBE UNITS / STORAGE CABINETS

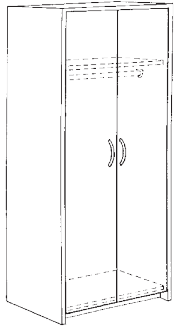

- Doors equipped with fully adjustable Blum hinges.
- Handles are 128mm black crescent pulls.

^{3/4"}
Self edge ^{3/4"}
175 **Hardwood**
675

WARDROBE UNITS

Wardrobe units include hat shelf and hanging coat rod.

24x24x72	185	WARD 2472
30x24x72	210	WARD 3072
36x24x72	235	WARD 3672
24x24x78	200	WARD 2478
30x24x78	225	WARD 3078
36x24x78	250	WARD 3678

STORAGE CABINETS

Storage cabinets include fixed shelf at 30" AFF, with one adjustable shelf below and two above. Additional shelves are priced individually.

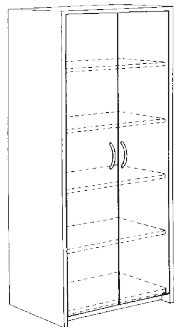

24x24x72	220	SCAB 2472
30x24x72	255	SCAB 3072
36x24x72	290	SCAB 3672
24x24x78	235	SCAB 2478
30x24x78	270	SCAB 3078
36x24x78	305	SCAB 3678

STORAGE CABINET SHELVES

22x22x1¼	12	SCCS 2422
28x22x1¼	15	SCCS 3022
34x22x1¼	18	SCCS 3622



COMBINATION WARDROBE/STORAGE UNITS

Combo units have fixed vertical center divider, with hat shelf and coat rod left and four adjustable shelves right. Additional shelves are priced individually.

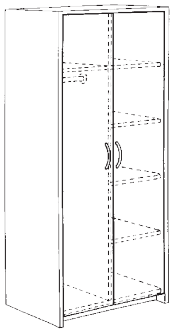

24x24x72	220	WSCB 2472
30x24x72	255	WSCB 3072
36x24x72	290	WSCB 3672
24x24x78	235	WSCB 2478
30x24x78	270	WSCB 3078
36x24x78	305	WSCB 3678

COMBO CABINET SHELVES

11x22x1¼	6	SCCS 1222
14x22x1¼	8	SCCS 1522
17x22x1¼	9	SCCS 1822



Size (WDH) Weight Model No. Price

STUDY CARRELS

- Modular approach allows runs or clusters of any number.
- All units ship KD for ease of handling and join together easily with shoulder screw/clip system.
- Starter unit includes two 36x1¼x48" h end panels with adjustable glides, 33½x1¼x48" h back panel, 24" d worksurface which mounts at 29" AFF desk height, 12" d shelf which mounts at 42" AFF, and all necessary hardware.
- Add-on units mount left-to-right and include same components as starter unit, but with only one (RH) end panel.
- Electrified grommets and various wire management options are available on HLF study carrels — consult factory for specification information and pricing.
- Specify model number and edge treatment (i.e., SCSU 3648 (100)).

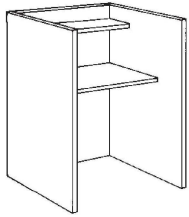

STARTER UNIT
 36x36x48 260 SCSU 3648

1¼" 1¼"
Self edge Hardwood
100 600

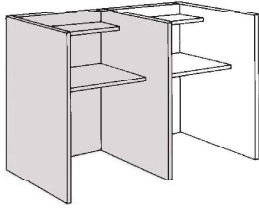

ADD-ON UNIT
 34¾x36x48 190 SCAO 3648

CARREL ACCESSORIES

TASK LIGHTING



24" w fluorescent fixture mounts under shelf.
 24x5x2 LITE 0024



GROMMET

Black vinyl 2½" dia. with punch-out wire manager.
 Factory installed in worksurface — specify location.
 2½" dia. FIGROM



TACKABLE PANEL

Tackable acoustically treated pane finished in Guilford FR701, Pattern 2100.
 Mounts between worksurface and shelf.
 34x¾x13 TACK 3413

OPTIONS

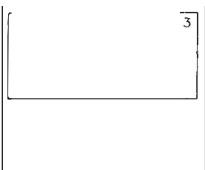

Grommet Locator

Size (WDH)	Model No.	Weight	Price	Number of Shelves	Features
------------	-----------	--------	-------	-------------------	----------

COMMERCIAL CABINETS

- All fully modular in 6" increments.
- All cabinets constructed of ¾" melamine clad industrial grade particle board, and are available in any of our 12 Basics finishes. Door and drawer faces may be finished in standard laminates at the Column A price, Basics low pressure finishes at the Column B price or any non-standard finish by adding the appropriate upcharge to the Column A price.
- Please note: Please specify desired Basics color for cabinet.
- If no color is specified, cabinet will be produced in M-11 White.
- All drawer and door faces are self edge.
- All wood drawer construction lined in white melamine.
- Blum hinges on all door units.
- Handles are 128mm black crescent pulls, standard.
- COM handles will be installed at no additional charge if received at factory PREPAID before production begins.
- All tops are high pressure laminate clad.

A
Standard
HPL Faces

B
Basics
LPL Faces

SINK BASE CABINETS

False drawerface. Open back for plumbing access.



24x24x34¾	80	CLSB 2424
30x24x34¾	88	CLSB 3024
36x24x34¾	100	CLSB 3624
42x24x34¾	112	CLSB 4224

FOUR DRAWER CABINETS



24x24x34¾	104	CL4D 2424
30x24x34¾	124	CL4D 3024
36x24x34¾	148	CL4D 3624
42x24x34¾	172	CL4D 4224

ONE DRAWER, TWO DOOR BASE CABINETS



24x24x34¾	96	CLDD 2424
30x24x34¾	116	CLDD 3024
36x24x34¾	140	CLDD 3624
42x24x34¾	164	CLDD 4224

TWO DOOR UPPER STORAGE CABINETS

Note: Installer must ensure adequate support for wall hanging. 12" inside depth. Two adjustable shelves. Optional valance — \$.

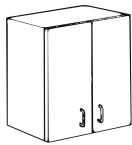

24x14x30	108	CUTD 2414
30x14x30	124	CUTD 3014
36x14x30	148	CUTD 3614
42x14x30	168	CUTD 4214

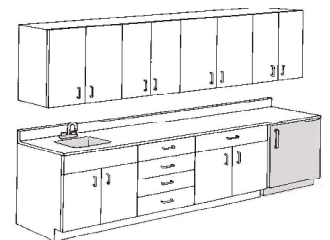

Size (WDH) Weight Model No. Price

COMMERCIAL CABINETRY

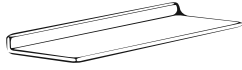

COUNTERTOPS

In between sizes, specify desired size and use price of next largest. Includes 4" h backsplash, shipped separately. 24" d x 4" h sidesplash — \$. Postform front edge — add 10%.

			A Standard HPL Faces	B Basics LPL Faces
24x25x1½	30	CCTP 02425		
36x25x1½	45	CCTP 03625		
48x25x1½	60	CCTP 04825		
60x25x1½	75	CCTP 06025		
72x25x1½	90	CCTP 07225		
84x25x1½	100	CCTP 08425		
96x25x1½	115	CCTP 09625		
120x25x1½	140	CCTP 12025		
144x25x1½	165	CCTP 14425		

UPPER SHELF UNITS

Three shelf unit includes fixed top shelf and two adjustable shelves on each side of fixed center divider. Heavy duty 1¼" slab construction. Select Column A for high pressure standard laminate finishes or Column B for Basics melamine finishes in our 12 standard Basics colors. For non-standard laminates, add the appropriate upcharge to the Column A price.

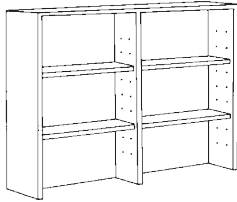

48x12x42	220	CMUS 4842		
54x12x42	240	CMUS 5442		
60x12x42	260	CMUS 6042		
66x12x42	288	CMUS 6642		
72x12x42	300	CMUS 7242		
<hr/>				
48x12x48	240	CMUS 4848		
54x12x48	260	CMUS 5448		
60x12x48	282	CMUS 6048		
66x12x48	306	CMUS 6648		
72x12x48	324	CMUS 7248		

UPPER SHELF UNITS WITH DOORS

Blum hinges on all doors. Cabinet section is 24" h with one adjustable shelf in each section. 48" and 54" units have three doors, with single door section on right. Other units have four doors.

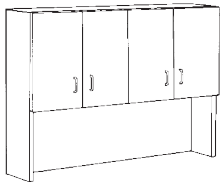

48x12x42	252	CMUD 4842		
54x12x42	275	CMUD 5442		
60x12x42	295	CMUD 6042		
66x12x42	336	CMUD 6642		
72x12x42	350	CMUD 7242		
<hr/>				
48x12x48	272	CMUD 4848		
54x12x48	295	CMUD 5448		
60x12x48	317	CMUD 6048		
66x12x48	354	CMUD 6648		
72x12x48	374	CMUD 7248		

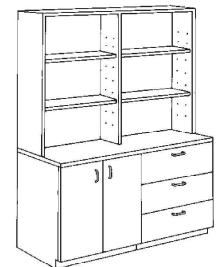

HLF FURNITURE, INC.

44001 VAN BORN ROAD • BELLEVILLE, MICHIGAN 48111

(313) 697-3000 • FAX (313) 697-3008

