

CounterPoint™  
A Worksurface-  
Based  
Office Furniture

# Price List

EFFECTIVE JULY 15, 2008

This Price List is a resource for a Designer/Specifier to use in identifying and ordering the appropriate CounterPoint components to create functional and attractive interior environments. As illustrated in the diagram on the following page, CounterPoint components listed in this guide are organized into seven sections according to their use:

1. Worksurfaces
2. Lower Storage
3. Lower Support
4. Upper Storage
5. Building Towers
6. Privacy Screens
7. Lighting, Electrical and Accessories

This abbreviated format is organized in the same sequence that can be used to quickly and easily create a written specification for a project. Beginning with Worksurface configurations and following section by section through Lighting, Electrical and Accessories, this Price List includes general information about the items included in each section as well as details about specific product in each category.

Along with product descriptions, model numbers and sizes, approximate weights are given. These weights include packaging materials and can be used to estimate shipping costs.

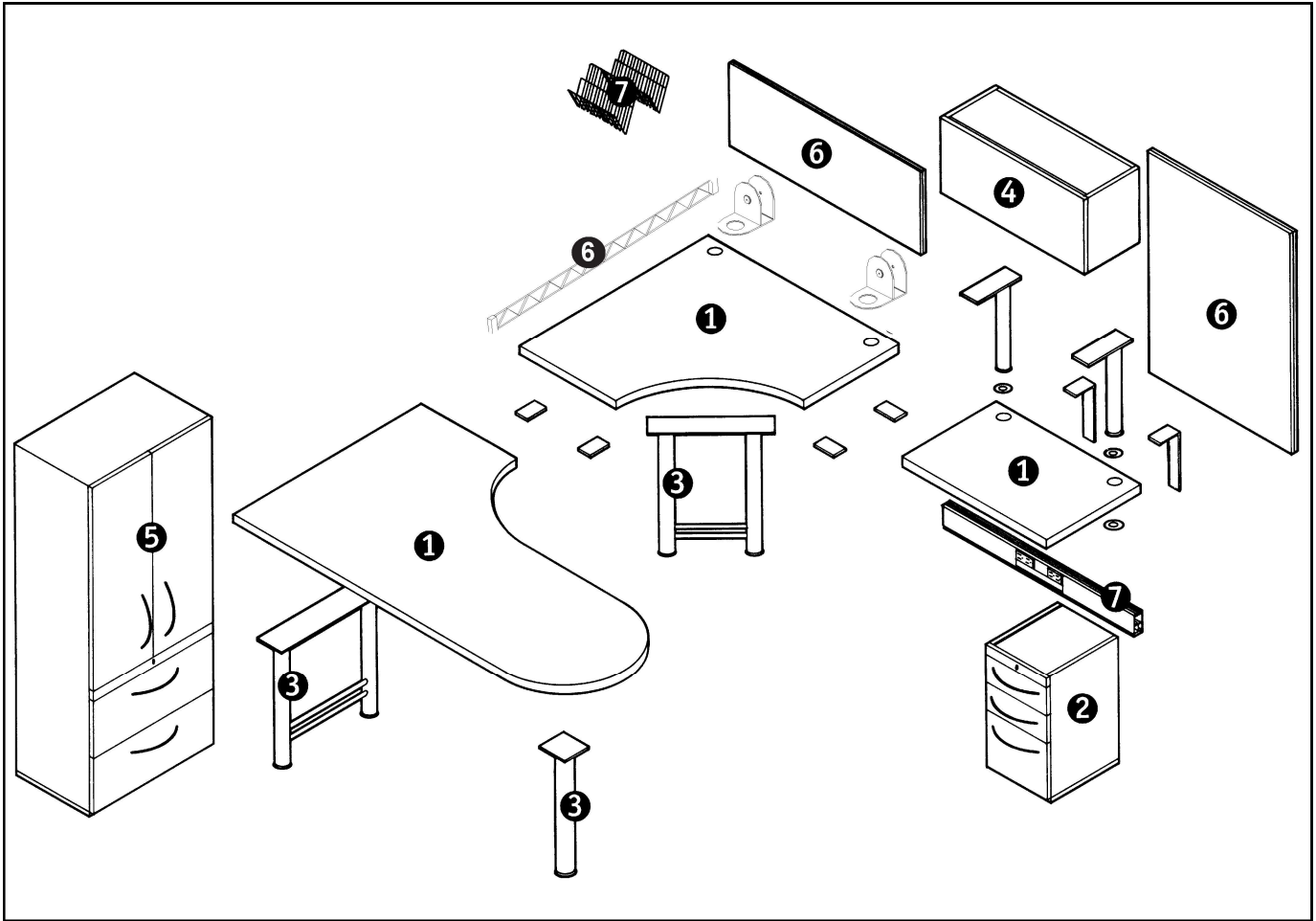

---

HOW TO USE THIS PRICE LIST

Written product specifications are created using the CounterPoint model number system. The model number serves as a convenient product code as well as a secondary description of the item and its size:

- The first two digits indicate the section of this Price List in which the item is located. (i.e., C1RW7220 — C1 = CounterPoint Section One Worksurfaces.
- The second two letters are initials for the product description. (i.e., C1RW7220 — RW = Rectangular Worksurface.)
- The remaining numbers indicate width followed by depth. (i.e., C1RW7220 — 7220 = 72" wide x 20" deep.)
- In some cases, the depth may be followed by a slash (/) and additional numbers which give connecting runoff sizes. (i.e., C1CW42/2024 = CounterPoint Worksurfaces 42" Corner Worksurface with 20" left runoff and 24" right runoff.)
- For items which require finish designation, the specifier should conclude the model number with a hyphen followed by the appropriate finish category; (1) laminate with PVC edge, (2) laminate with wood edge, (3) veneer with wood edge.

C O U N T E R P O I N T P R I C E L I S T

① \_\_\_\_\_

② \_\_\_\_\_

③ \_\_\_\_\_

④ \_\_\_\_\_

⑤ \_\_\_\_\_

⑥ \_\_\_\_\_

⑦ \_\_\_\_\_

Ⓜ \_\_\_\_\_



C O U N T E R P O I N T P R I C E L I S T

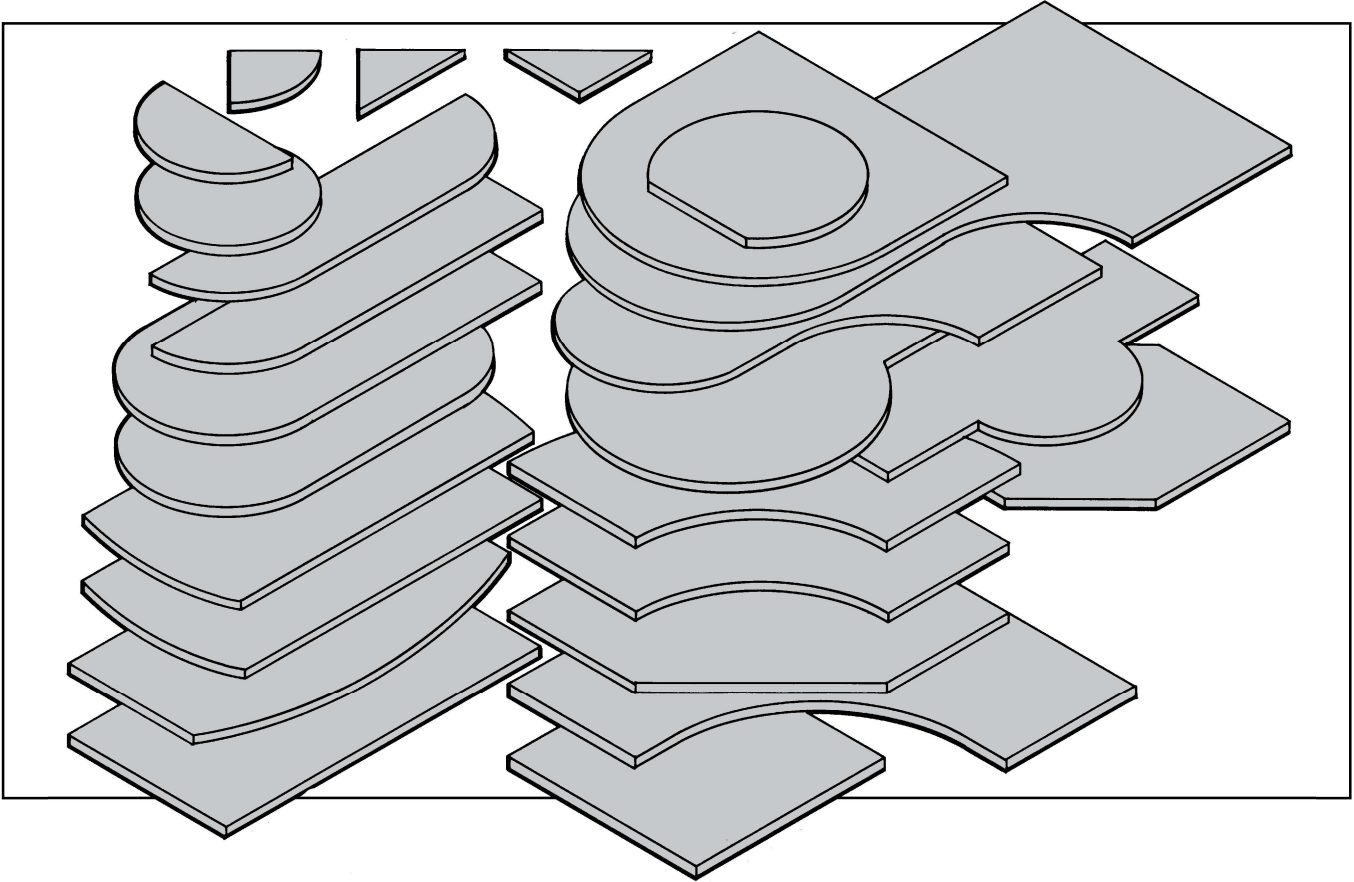

## GENERAL SPECIFICATIONS

- Finished thickness 1<sup>-5/8</sup>" (1<sup>-1/2</sup>" thick 45 lb. industrial particle board substrate with top surfaces and four edges finished as specified).
- Finish options are:
  - 1.Laminate with PVC edge
  - 2.Laminate with wood edge
  - 3.Wood veneer with wood edge
- Bottoms are finished with a full thickness balancing backer sheet.
- Dimensions indicate maximum overall width and depth except where noted.
- Each worksurface includes two joining plates with mounting screws.
- Threaded inserts are installed for the most commonly required joining configurations.
- Worksurfaces are supported by support elements and lower storage units.
- Lengths beyond 48" may require additional center support.
- For special applications and insert locations for support legs, see the Design and Specification Guide.



Description	Model No.	Size (WxD)	Wt.	Laminate w/PVC (1)	Laminate w/wood (2)	Veneer w/wood (3)
<b>RECTANGULAR WORKSURFACES</b>						
<b>12" DEEP RECTANGULAR WORKSURFACE</b>						
	C1RW2412	24x12	14			
	C1RW3012	30x12	18			
	C1RW3612	36x12	21			
	C1RW4212	42x12	25			
	C1RW4812	48x12	28			
	C1RW5412	54x12	32			
	C1RW6012	60x12	35			
	C1RW6612	66x12	39			
	C1RW7212	72x12	42			
	C1RW7812	78x12	46			
	C1RW8412	84x12	49			
	C1RW9012	90x12	53			
C1RW9612	96x12	56				
<b>18" DEEP RECTANGULAR WORKSURFACE</b>						
	C1RW2418	24x18	21			
	C1RW3018	30x18	27			
	C1RW3618	36x18	32			
	C1RW4218	42x18	37			
	C1RW4818	48x18	42			
	C1RW5418	54x18	48			
	C1RW6018	60x18	53			
	C1RW6618	66x18	58			
	C1RW7218	72x18	63			
	C1RW7818	78x18	69			
	C1RW8418	84x18	74			
	C1RW9018	90x18	79			
C1RW9618	96x18	84				
<b>20" DEEP RECTANGULAR WORKSURFACE</b>						
	C1RW2420	24x20	24			
	C1RW3020	30x20	30			
	C1RW3620	36x20	35			
	C1RW4220	42x20	41			
	C1RW4820	48x20	47			
	C1RW5420	54x20	53			
	C1RW6020	60x20	59			
	C1RW6620	66x20	64			
	C1RW7220	72x20	70			
	C1RW7820	78x20	76			
	C1RW8420	84x20	82			
	C1RW9020	90x20	88			
C1RW9620	96x20	94				

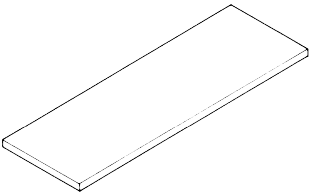
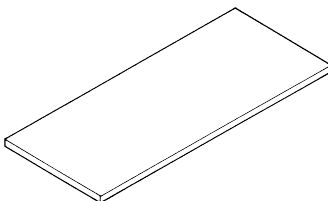
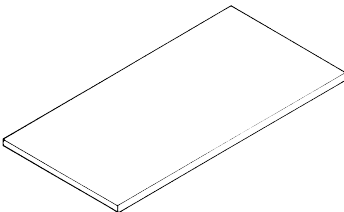

Description	Model No.	Size (WxD)	Wt.	Laminate	Laminate	Veneer
				w/PVC (1)	w/wood (2)	w/wood (3)
<b>24" DEEP RECTANGULAR WORKSURFACE</b> 	C1RW2424	24x24	28			
	C1RW3024	30x24	35			
	C1RW3624	36x24	42			
	C1RW4224	42x24	49			
	C1RW4824	48x24	56			
	C1RW5424	54x24	63			
	C1RW6024	60x24	70			
	C1RW6624	66x24	77			
	C1RW7224	72x24	84			
	C1RW7824	78x24	91			
	C1RW8424	84x24	98			
	C1RW9024	90x24	105			
	C1RW9624	96x24	112			
<b>30" DEEP RECTANGULAR WORKSURFACE</b> 	C1RW3030	30x30	44			
	C1RW3630	36x30	53			
	C1RW4230	42x30	62			
	C1RW4830	48x30	70			
	C1RW5430	54x30	79			
	C1RW6030	60x30	88			
	C1RW6630	66x30	97			
	C1RW7230	72x30	105			
	C1RW7830	78x30	114			
	C1RW8430	84x30	123			
	C1RW9030	90x30	132			
C1RW9630	96x30	140				
<b>36" DEEP RECTANGULAR WORKSURFACE</b> 	C1RW3036	30x36	53			
	C1RW3636	36x36	63			
	C1RW4236	42x36	74			
	C1RW4836	48x36	84			
	C1RW5436	54x36	95			
	C1RW6036	60x36	105			
	C1RW6636	66x36	116			
	C1RW7236	72x36	126			
	C1RW7836	78x36	137			
	C1RW8436	84x36	147			
	C1RW9036	90x36	158			
C1RW9636	96x36	168				



Description	Model No.	Size (WxD)	Wt.	Laminate	Laminate	Veneer
				w/PVC	w/wood	w/wood
CORNER WORKSURFACES				(1)	(2)	(3)

- Specify the left and right run off sizes.
- The length of the diagonal edge may restrict the use of a pencil drawer or an articulating keyboard tray. See the Design and Specification Guide for details.
- Bottoms are drilled for connecting runoff edges and for proper support elements.

## CORNER WORKSURFACE

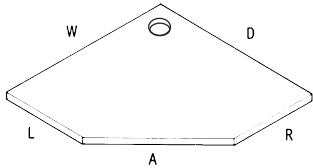

C1CW36/LR	36x36	63
C1CW42/LR	42x42	86
C1CW48/LR	48x48	112

Corner worksurfaces are available with the following left and right runoff sizes:

L	R	A(CW36)	A(CW42)	A(CW48)
20	20	22.5	31	39.5
20	24	20	28.5	36.5
20	30	17	25	33
24	20	20	28.5	36.5
24	24	16.5	25.5	34
24	30	13	21.5	30
30	20	17	25	33
30	24	13	21.5	30
30	30	8.5	17	25.5

## INSIDE RADIUS WORKSURFACE

- Specify the left and right runoff sizes.
- The size of the inside radius may restrict the use of a pencil drawer or an articulating keyboard tray. See the Design and Specification Guide for details.
- Bottoms are drilled for connecting runoff edges and for proper support elements.

## INSIDE RADIUS WORKSURFACE

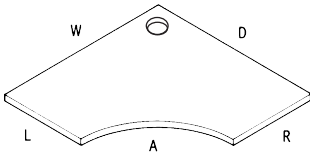

C1CI42/LR	42x42	86
C1CI48/LR	48x48	112

Inside radius worksurfaces are available with the following left and right runoff sizes (A=radius):

L	R	A(CI42)	A(CI48)
20	20	22	28
20	24	18	24
20	30	12	18
24	20	18	24
24	24	18	24
24	30	12	18
30	20	12	18
30	24	12	18
30	30	12	18

Description	Model No.	Size (WxD)	Wt.	Laminate	Laminate	Veneer
				w/PVC (1)	w/wood (2)	w/wood (3)

**CORNER STATION**

- Specify the left and right runoff sizes.
- See the Design and Specification Guide for the suggested support elements.

**CORNER STATION**

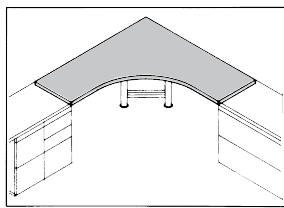
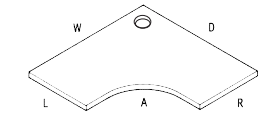

C1CS54/LR	54x54	142
C1CS60/LR	60x60	175

Corner stations are available with the following left and right runoff sizes (A=radius):

L	R	A(CS54)	A(CS60)
20	20	28	28
20	24	28	28
20	30	24	28
24	20	28	28
24	24	28	28
24	30	24	28
30	20	24	28
30	24	24	28
30	30	24	28

**EXTENDED CORNER WORKSURFACE**

- Specify the left and right runoff sizes.

**EXTENDED CORNER RIGHT HAND**

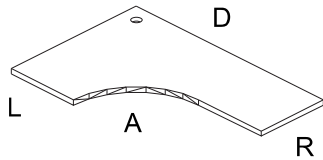

C1CX4260/LR	42x60	107
C1CX4266/LR	42x66	110
C1CX4272/LR	42x72	116
C1CX4860/LR	48x60	133
C1CX4866/LR	48x66	136
C1CX4872/LR	48x72	142

Extended corners are available in the following runoff sizes (A=radius):

L	R	A(CX42)	A(CX48)
20	20	22	28
20	24	18	24
20	30	12	18
24	20	22	23
24	24	18	24
24	30	12	18
30	20	22	28
30	24	18	24
30	30	12	18

**EXTENDED CORNER LEFT HAND**

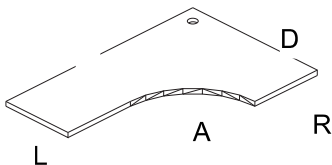

C1CX6042/LR	60x42	107
C1CX6642/LR	66x42	110
C1CX7242/LR	72x42	116
C1CX6048/LR	60x48	133
C1CX6648/LR	66x48	136
C1CX7248/LR	72x48	142

Extended corners are available in the following runoff sizes (A=radius):\*

\*See above chart for runoff sizes



Description	Model No.	Size (WxDxA)	Wt.	Laminate w/PVC	Laminate w/wood	Veneer w/wood
<b>CORNER POD WORKSURFACE</b>				(1)	(2)	(3)

- Specify the depth of the worksurface.
- The angle of the back edge is 120°
- Dimensions indicate the length of the back edges.

**CORNER POD WORKSURFACE**

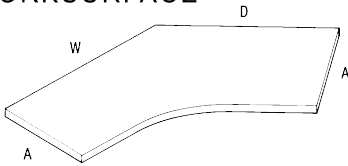

C1CP48/20	48x48x20	112
C1CP48/24	48x48x24	112
C1CP48/30	48x48x30	112
C1CP60/20	60x60x20	175
C1CP60/24	60x60x24	175
C1CP60/30	60x60x30	175
C1CP72/20	72x72x20	252
C1CP72/24	72x72x24	252

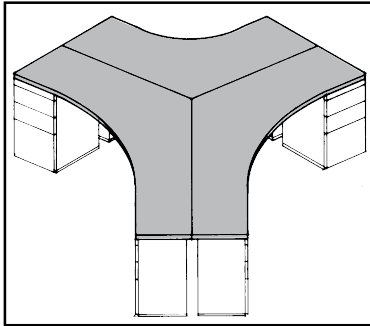

**DOUBLE RADIUS CORNER STATION**

- Specify the depth of the worksurface.
- See the Design and Specification Guide for outside and inside radius dimensions.

**DOUBLE RADIUS CORNER STATION**



C1CR54/D	54" RAD	142
C1CR60/D	60" RAD	175

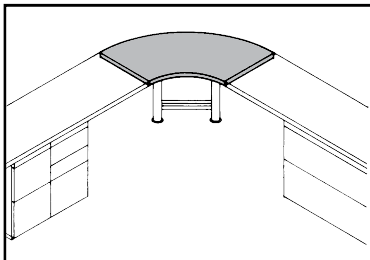

Description	Model No.	Size (A x B x C x D)	Wt.	Laminate	Laminate	Veneer
				w/PVC (1)	w/wood (2)	w/wood (3)

**CONFERENCE CORNER**  
 · The inside curve radius is 18".  
 · See the Design and Specification Guide for suggested support elements.

**CONFERENCE CORNER LEFT HANDED**

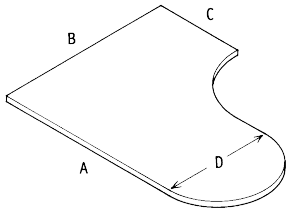

C1CC6648L/20	66x48x20x30	133
C1CC6648L/24	66x48x24x30	133
C1CC6648L/30	66x48x30x30	133
C1CC7848L/20	78x48x20x30	151
C1CC7848L/24	78x48x24x30	151
C1CC7848L/30	78x48x30x30	151
C1CC9048L/20	90x48x20x30	169
C1CC9048L/24	90x48x24x30	169
C1CC9048L/30	90x48x30x30	169

**CONFERENCE CORNER RIGHT HANDED**

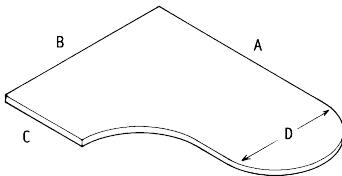

C1CC6648R/20	66x48x20x30	133
C1CC6648R/24	66x48x24x30	133
C1CC6648R/30	66x48x30x30	133
C1CC7848R/20	78x48x20x30	151
C1CC7848R/24	78x48x24x30	151
C1CC7848R/30	78x48x30x30	151
C1CC9048R/20	90x48x20x30	169
C1CC9048R/24	90x48x24x30	169
C1CC9048R/30	90x48x30x30	169

**"P" TOP**

· See the Design and Specification Guide for suggested support elements.

**72" WIDE "P" TOP LEFT HANDED**

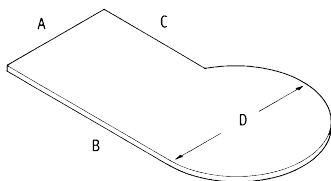

C1PT7236L	24x72x37x36	92
C1PT7242L	30x72x32x42	114
C1PT7248L	36x72x27.25x48	135
C1PT7254L	36x72x19.5x54	156

**72" WIDE "P" TOP RIGHT HANDED**

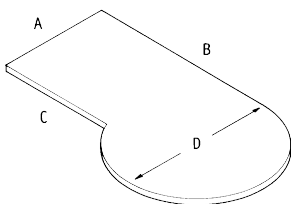

C1PT7236R	24x72x37x36	92
C1PT7242R	30x72x32x42	114
C1PT7248R	36x72x27.25x48	135
C1PT7254R	36x72x19.5x54	156





Description	Model No.	Size (A x B x C x D)	Wt.	Laminate	Laminate	Veneer
				w/PVC (1)	w/wood (2)	w/wood (3)

84" WIDE "P" TOP  
LEFT HANDED

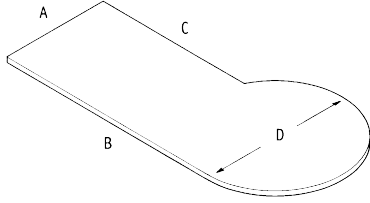

C1PT8436L	24x84x49x36	106
C1PT8442L	30x84x44x42	132
C1PT8448L	36x84x39.25x48	156
C1PT8454L	36x84x31.5x54	181

84" WIDE "P" TOP  
RIGHT HANDED

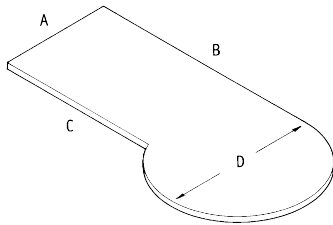

C1PT8436R	24x84x49x36	106
C1PT8442R	30x84x44x42	132
C1PT8448R	36x84x39.25x48	156
C1PT8454R	36x84x31.5x54	181

96" WIDE "P" TOP  
LEFT HANDED

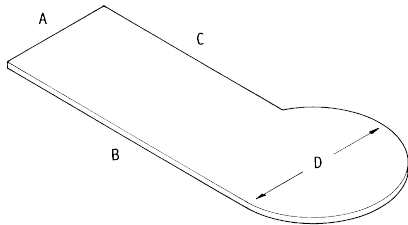

C1PT9636L	24x96x61x36	120
C1PT9642L	30x96x56x42	150
C1PT9648L	36x96x51.25x48	177
C1PT9654L	36x96x43.5x54	206

96" WIDE "P" TOP  
RIGHT HANDED

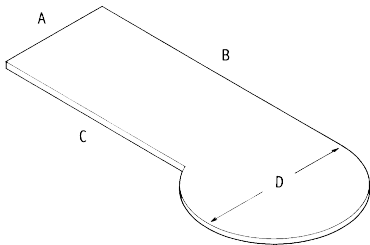

C1PT9636R	24x96x61x36	120
C1PT9642R	30x96x56x42	150
C1PT9648R	36x96x51.25x48	177
C1PT9654R	36x96x43.5x54	206

Description	Model No.	Size (A x B x C x D x E)	Wt.	Laminate w/PVC	Laminate w/wood	Veneer w/wood
				(1)	(2)	(3)

**PENINSULA WORKSURFACES**

- The diameter of the conference end is 42".
- See the Design and Specification Guide for suggested support elements.

**PENINSULA WORKSURFACE  
LEFT HANDED**

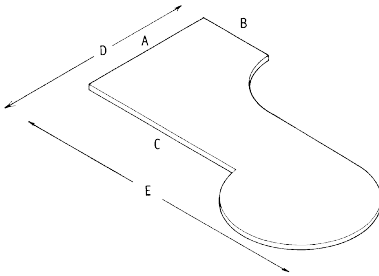

C1PW9060L/24	48x24x50x60x90	159
C1PW9060L/30	48x30x50x60x90	166
C1PW9660L/24	48x24x56x60x96	165
C1PW9660L/30	48x30x56x60x96	173

**PENINSULA WORKSURFACE  
RIGHT HANDED**

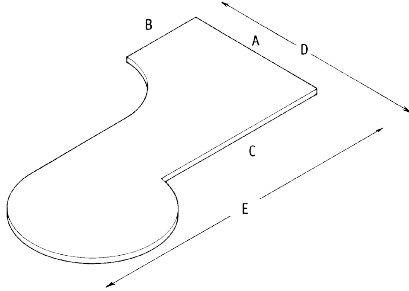

C1PW9060R/24	48x24x50x60x90	159
C1PW9060R/30	48x30x50x60x90	166
C1PW9660R/24	48x24x56x60x96	165
C1PW9660R/30	48x30x56x60x96	173

**BULLET WORKSURFACE**

- Bottoms are drilled on both sides at the square end and include inserts for joining 20", 24" and 30" surfaces.
- Inserts are included for the suggested support element for the round end. See the Design and Specification Guide for details.

**24" DEEP BULLET  
WORKSURFACE**

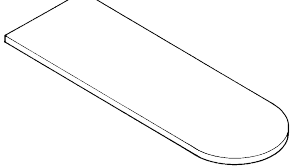

C1BW4224	42x24	46
C1BW4824	48x24	53
C1BW5424	54x24	60
C1BW6024	60x24	67
C1BW6624	66x24	74
C1BW7224	72x24	81
C1BW7824	78x24	88
C1BW8424	84x24	95

**30" DEEP BULLET WORKSURFACE**

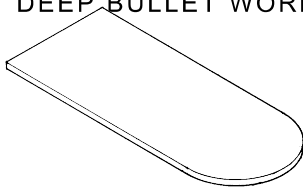

C1BW4230	42x30	57
C1BW4830	48x30	65
C1BW5430	54x30	74
C1BW6030	60x30	83
C1BW6630	66x30	92
C1BW7230	72x30	101
C1BW7830	78x30	118
C1BW8430	84x30	135

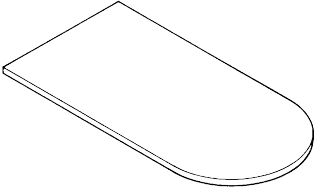

Description	Model No.	Size (WxD)	Wt.	Laminate	Laminate	Veneer
				w/PVC (1)	w/wood (2)	w/wood (3)
<b>36" DEEP BULLET WORKSURFACE</b>  	C1BW4236	42x36	67			
	C1BW4836	48x36	77			
	C1BW5436	54x36	88			
	C1BW6036	60x36	98			
	C1BW6636	66x36	109			
	C1BW7236	72x36	121			
	C1BW7836	78x36	140			
	C1BW8436	84x36	159			

#### BOW END WORKSURFACE

- Bottoms are drilled on both sides at the square end and include inserts for joining 20", 24" and 30" surfaces.
- Inserts are included for the suggested support elements for the radius end. See the Design and Specification Guide for details.

#### 30" DEEP BOW END WORKSURFACE

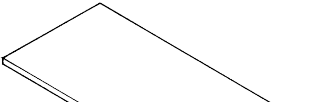
	C1BE4830	48x30	68
	C1BE5430	54x30	77
	C1BE6030	60x30	86
	C1BE6630	66x30	95
	C1BE7230	72x30	104
	C1BE8430	84x30	121

#### 36" DEEP BOW END WORKSURFACE

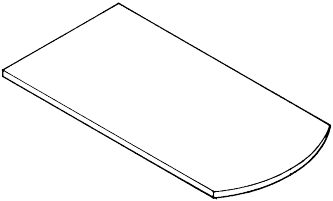
	C1BE4836	48x36	82
	C1BE5436	54x36	93
	C1BE6036	60x36	103
	C1BE6636	66x36	114
	C1BE7236	72x36	126
	C1BE8436	84x36	145

Description	Model No.	Size (WxD)	Wt.	Laminate w/PVC	Laminate w/wood	Veneer w/wood
				(1)	(2)	(3)

**DOUBLE END BOW**

· Bottoms are drilled and include inserts for the suggested support elements. See the Design and Specification Guide for details.

**30" DEEP DOUBLE END BOW**

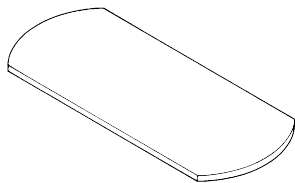

C1DB4830	48x30	65
C1DB5430	54x30	74
C1DB6030	60x30	83
C1DB6630	66x30	92
C1DB7230	72x30	101
C1DB8430	84x30	118

**36" DEEP DOUBLE END BOW**

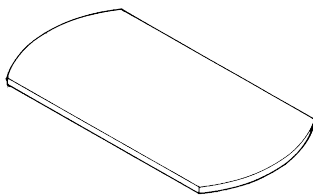

C1DB4836	48x36	67
C1DB5436	54x36	77
C1DB6036	60x36	88
C1DB6636	66x36	98
C1DB7236	72x36	109
C1DB8436	84x36	121

**SINGLE END RADIUS WORKSURFACE**

· Radius of the end curve is equal to the depth of the surface.  
 · Inserts are included in the bottom for joining 20", 24" and 30" surfaces to the back edge.  
 · NOTE: 18" Deep surfaces available using 20" deep pricing

**20" DEEP SINGLE END RADIUS WORKSURFACE LEFT HANDED**

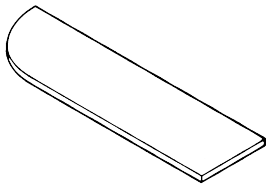

C1SR3020L	30x20	25
C1SR3620L	36x20	37
C1SR4220L	42x20	43
C1SR4820L	48x20	49
C1SR5420L	54x20	55
C1SR6020L	60x20	61
C1SR6620L	66x20	67
C1SR7220L	72x20	77
C1SR8420L	84x20	83
C1SR9620L	96x20	89

**20" DEEP SINGLE END RADIUS WORKSURFACE RIGHT HANDED**

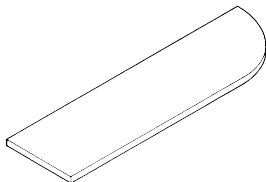

C1SR3020R	30x20	25
C1SR3620R	36x20	37
C1SR4220R	42x20	43
C1SR4820R	48x20	49
C1SR5420R	54x20	55
C1SR6020R	60x20	61
C1SR6620R	66x20	67
C1SR7220R	72x20	77
C1SR8420R	84x20	83
C1SR9620R	96x20	89

1

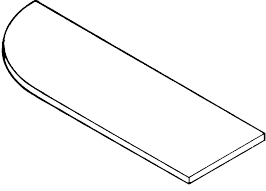
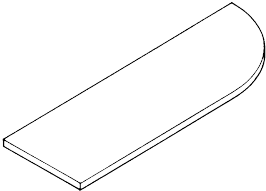
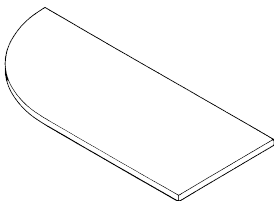
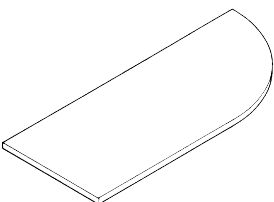
Description	Model No.	Size (WxD)	Wt.	Laminate	Laminate	Veneer
				w/PVC (1)	w/wood (2)	w/wood (3)
24" DEEP SINGLE END RADIUS WORKSURFACE LEFT HANDED  	C1SR3024L	30x24	29			
	C1SR3624L	36x24	36			
	C1SR4224L	42x24	43			
	C1SR4824L	48x24	50			
	C1SR5424L	54x24	57			
	C1SR6024L	60x24	64			
	C1SR6624L	66x24	71			
	C1SR7224L	72x24	78			
	C1SR8424L	84x24	92			
	C1SR9624L	96x24	106			
24" DEEP SINGLE END RADIUS WORKSURFACE RIGHT HANDED  	C1SR3024R	30x24	29			
	C1SR3624R	36x24	36			
	C1SR4224R	42x24	43			
	C1SR4824R	48x24	50			
	C1SR5424R	54x24	57			
	C1SR6024R	60x24	64			
	C1SR6624R	66x24	71			
	C1SR7224R	72x24	78			
	C1SR8424R	84x24	92			
	C1SR9624R	96x24	106			
30" DEEP SINGLE END RADIUS WORKSURFACE LEFT HANDED  	C1SR3630L	36x30	43			
	C1SR4230L	42x30	52			
	C1SR4830L	48x30	61			
	C1SR5430L	54x30	70			
	C1SR6030L	60x30	79			
	C1SR6630L	66x30	88			
	C1SR7230L	72x30	97			
	C1SR8430L	84x30	113			
	C1SR9630L	96x30	130			
	30" DEEP SINGLE END RADIUS WORKSURFACE RIGHT HANDED  	C1SR3630R	36x30	43		
C1SR4230R		42x30	52			
C1SR4830R		48x30	61			
C1SR5430R		54x30	70			
C1SR6030R		60x30	79			
C1SR6630R		66x30	88			
C1SR7230R		72x30	97			
C1SR8430R		84x30	113			
C1SR9630R		96x30	130			



Description	Model No.	Size (WxD)	Wt.	Laminate w/PVC	Laminate w/wood	Veneer w/wood
				(1)	(2)	(3)

**DOUBLE END RADIUS WORKSURFACES**

- Radius of the end curves are equal to the depth of the surface.
- Inserts are included in the bottom for joining 20", 24" and 30" surfaces to the back edge.
- NOTE: 18" deep surfaces available using 20" deep pricing.

**20" DEEP DOUBLE END RADIUS WORKSURFACE**

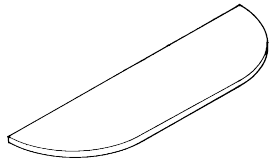

C1DR3020	30x20	21
C1DR3620	36x20	27
C1DR4220	42x20	33
C1DR4820	48x20	39
C1DR5420	54x20	43
C1DR6020	60x20	51
C1DR6620	66x20	57
C1DR7220	72x20	63
C1DR8420	84x20	75
C1DR9620	96x20	86

**24" DEEP DOUBLE END RADIUS WORKSURFACE**

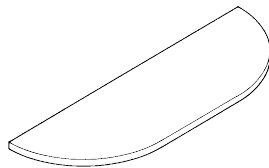

C1DR3024	30x24	23
C1DR3624	36x24	30
C1DR4224	42x24	37
C1DR4824	48x24	44
C1DR5424	54x24	51
C1DR6024	60x24	58
C1DR6624	66x24	65
C1DR7224	72x24	72
C1DR8424	84x24	86
C1DR9624	96x24	100

**30" DEEP DOUBLE END RADIUS WORKSURFACE**

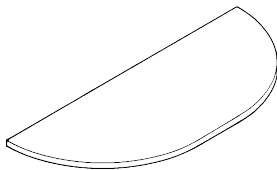

C1DR3630	36x30	34
C1DR4230	42x30	43
C1DR4830	48x30	52
C1DR5430	54x30	61
C1DR6030	60x30	70
C1DR6630	66x30	89
C1DR7230	72x30	98
C1DR8430	84x30	107
C1DR9630	96x30	116

①

Description	Model No.	Size (WxD)	Wt.	Laminate w/PVC	Laminate w/wood	Veneer w/wood
				(1)	(2)	(3)

**SPANNER WORKSURFACE**

- Radius is equal to  $1\frac{1}{4}$  the depth.

- Inserts are included for the suggested support elements. See the Design and Specification Guide for details and locations.

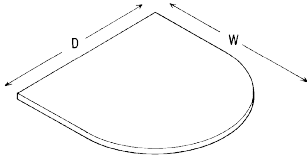
**SPANNER WORKSURFACE**

C1SP4840	48x40	95
C1SP4848	48x48	100
C1SP4854	48x54	110
C1SP4860	48x60	120

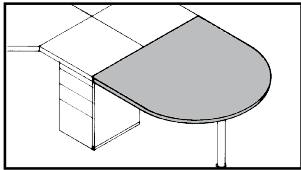
**QUARTER ROUND WORKSURFACE**

- Inserts are included for joining to both straight edges and for suggested support elements. See the Design and Specification Guide for details.

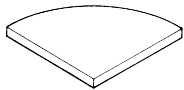
**QUARTER ROUND WORKSURFACE**

C1QR20	20" RAD	16
C1QR24	24" RAD	22
C1QR30	30" RAD	35
C1QR36	36" RAD	50
C1QR42	42" RAD	68

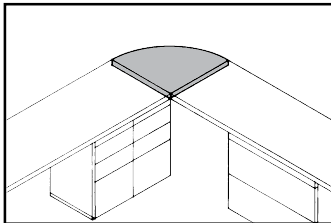
**HALF ROUND WORKSURFACE**

- Inserts are included for joining to the straight edge and for the suggested support elements. See the Design and Specification Guide for details.

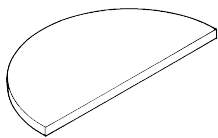
**HALF ROUND WORKSURFACE**

C1HR30	30" DIA	17
C1HR36	36" DIA	25
C1HR42	42" DIA	34
C1HR48	48" DIA	44
C1HR54	54" DIA	57
C1HR60	60" DIA	69

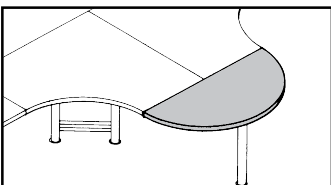



Description	Model No.	Size	Wt.	Laminate	Laminate	Veneer
				w/PVC	w/wood	w/wood
<b>FULL ROUND WORKSURFACE</b>				(1)	(2)	(3)

· Suggested for use with C3TB22, C3TB26, or C3TB32 Table Bases or with Single Support Legs.  
 Please specify with your order. See the Design and Specification Guide for the proper support elements and insert locations.

**FULL ROUND WORKSURFACE**

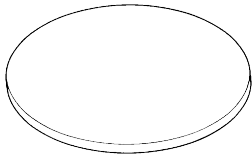

C1FR30	30" DIA	50
C1FR36	36" DIA	68
C1FR42	42" DIA	88
C1FR48	48" DIA	111
C1FR54	54" DIA	138
C1FR60	60" DIA	166

**FLAT TIRE WORKSURFACE**

· Specify the depth of the connecting work surface for the length of the straight edge.  
 · Inserts are included for proper joining along the straight edge.  
 · See the Design and Specification Guide for suggested support elements.

**FLAT TIRE WORKSURFACE**

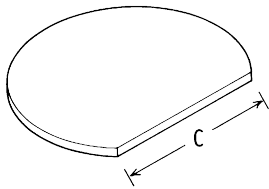

C1FT36/C	36" DIA	45
C1FT42/C	42" DIA	61
C1FT48/C	48" DIA	79
C1FT54/C	54" DIA	100
C1FT60/C	60" DIA	136

**TEAR DROP WORKSURFACE**

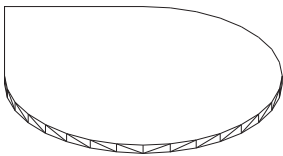

C1TD36/18		45
C1TD36/20		45
C1TD36/24		45
C1TD42/20		61
C1TD42/24		61
C1TD48/24		79
C1TD48/30		79





Description	Model No.	Size (WxD)	Wt.	Laminate w/PVC	Laminate w/wood	Veneer w/wood
EQUILATERAL TRIANGULAR WORKSURFACE				(1)	(2)	(3)

· The length of each side is given as "width" in the description. Inserts are included for joining the matching worksurfaces.

#### EQUILATERAL TRIANGULAR WORKSURFACE

C1TW20	20x20	9
C1TW24	24x24	12
C1TW30	30x30	19
C1TW36	36x36	28

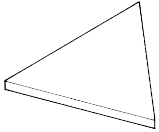

#### RIGHT TRIANGULAR WORKSURFACE

· See the Design and Specification Guide for the length of the hypotenuse.

#### RIGHT TRIANGULAR WORKSURFACE

C1TR20	20x20	10
C1TR24	24x24	14
C1TR30	30x30	22
C1TR36	36x36	32

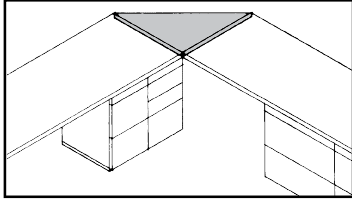

#### SQUARE WORKSURFACE

· See the Design and Specification Guide for selection of the proper support elements when used as a free standing table.

· Inserts for joining to other surfaces must be specified with order.

#### SQUARE WORKSURFACE

C1SW30	30x30	44
C1SW36	36x36	63
C1SW42	42x42	86
C1SW48	48x48	112
C1SW54	54x54	142
C1SW60	60x60	175

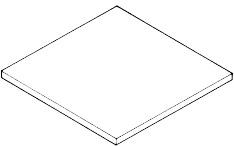

Description	Model No.	Size (WxD)	Wt.	Laminate	Laminate	Veneer
				w/PVC	w/wood	w/wood

**BOW FRONT WORKSURFACE**

- The depth of the surface is measured from the back edge to the front of the curve at the center of the arc.
- Inserts are included for the support elements on 30" and 36" deep surfaces only. See the Design and Specification Guide for the suggested support elements.

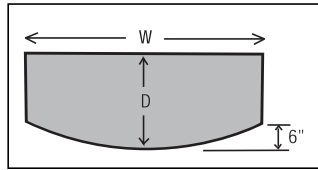
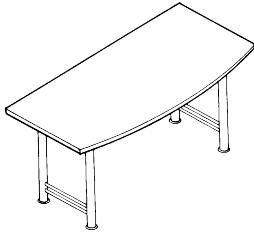

**14" DEEP BOW FRONT WORKSURFACE**

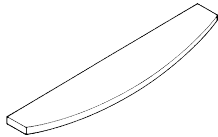

C1BF3014	30x14	16	323	476	596
C1BF3614	36x14	21	334	488	624
C1BF4214	42x14	24	355	508	714
C1BF4814	48x14	28	368	521	745
C1BF5414	54x14	31	380	533	783
C1BF6014	60x14	35	399	550	817
C1BF6614	66x14	38	420	570	846
C1BF7214	72x14	42	447	600	875
C1BF7814	78x14	46	476	630	905
C1BF8414	84x14	50	503	659	919
C1BF9614	96x14	54	532	688	934

**18" DEEP BOW FRONT WORKSURFACE**

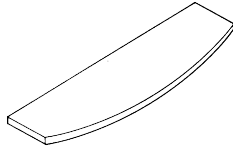

C1BF3018	30x18	25	340	509	655
C1BF3618	36x18	29	352	521	682
C1BF4218	42x18	34	372	541	788
C1BF4818	48x18	38	385	555	805
C1BF5418	54x18	44	398	566	842
C1BF6018	60x18	48	415	583	875
C1BF6618	66x18	52	434	603	891
C1BF7218	72x18	56	453	622	908
C1BF7818	78x18	60	483	652	938
C1BF8418	84x18	64	513	681	967
C1BF9618	96x18	68	542	711	997

**20" DEEP BOW FRONT WORKSURFACE**

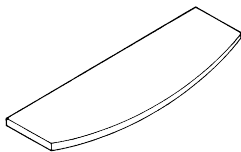

C1BF3020	30x20	27	352	521	687
C1BF3620	36x20	32	363	533	719
C1BF4220	42x20	37	378	547	816
C1BF4820	48x20	43	391	560	847
C1BF5420	54x20	48	411	578	886
C1BF6020	60x20	54	426	594	921

**24" DEEP BOW FRONT WORKSURFACE**

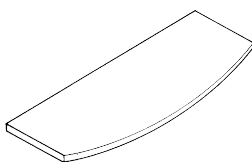

C1BF3024	30x24	32	361	462	744
C1BF3624	36x24	38	376	473	818
C1BF4224	42x24	44	385	482	861
C1BF4824	48x24	51	399	494	921
C1BF5424	54x24	57	420	512	993
C1BF6024	60x24	63	432	596	1051

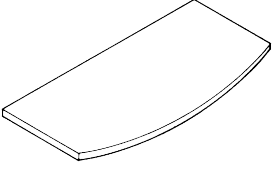

Description	Model No.	Size (WxD)	Wt.	Laminate	Laminate	Veneer
				w/PVC (1)	w/wood (2)	w/wood (3)
30" DEEP BOW FRONT WORKSURFACE  	C1BF3030	30x30	40	383	553	818
	C1BF3630	36x30	48	401	569	872
	C1BF4230	42x30	56	469	637	944
	C1BF4830	48x30	63	490	658	1026
	C1BF5430	54x30	72	516	686	1113
	C1BF6030	60x30	80	538	708	1153
	C1BF6630	66x30	88	568	737	1245
	C1BF7230	72x30	95	591	761	1281
C1BF8430	84x30	103	640	809	1605	

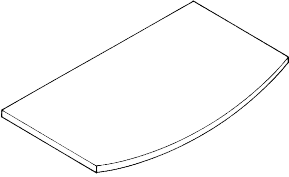
36" DEEP BOW FRONT WORKSURFACE  	C1BF3036	30x36	48	417	588	847
	C1BF3636	36x36	57	434	603	902
	C1BF4236	42x36	67	502	670	974
	C1BF4836	48x36	76	524	693	1054
	C1BF5436	54x36	86	550	719	1141
	C1BF6036	60x36	95	571	742	1169
	C1BF6636	66x36	105	601	770	1274
	C1BF7236	72x36	114	625	794	1311
C1BF8436	84x36	133	674	843	1635	

#### RACE TRACK WORKSURFACE

· See the Design and Specification Guide for the suggested support elements. Specify the support to be used when ordering.

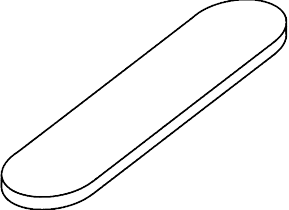
12" DEEP RACE TRACK WORKSURFACE  	C1RT3012	30x12	16	323	476	596
	C1RT3612	36x12	21	334	488	624
	C1RT4212	42x12	24	355	508	714
	C1RT4812	48x12	28	368	521	745
	C1RT5412	54x12	31	380	533	783
	C1RT6012	60x12	35	399	550	817
	C1RT6612	66x12	38	420	570	846
	C1RT7212	72x12	42	447	600	875

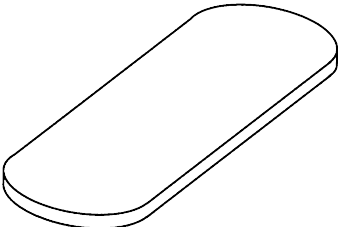
18" DEEP RACE TRACK WORKSURFACE  	C1RT3018	30x18	25	340	509	655
	C1RT3618	36x18	29	352	521	682
	C1RT4218	42x18	34	372	541	774
	C1RT4818	48x18	38	385	555	805
	C1RT5418	54x18	44	398	566	842
	C1RT6018	60x18	48	415	583	875
	C1RT6618	66x18	52	435	605	897
	C1RT7218	72x18	56	465	634	919



Description	Model No.	Size (WxD)	Wt.	Laminate	Laminate	Veneer
				w/PVC (1)	w/wood (2)	w/wood (3)
30" DEEP RACE TRACK WORKSURFACE	C1RT6030	60x30	75	640	974	1324
	C1RT6630	66x30	87	652	990	1577
	C1RT7230	72x30	96	677	1015	1758
	C1RT8430	84x30	114	726	1065	1942
	C1RT9630	96x30	131	770	1109	2136

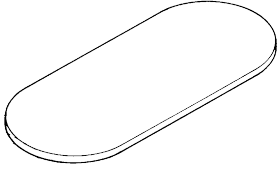

36" DEEP RACE TRACK WORKSURFACE	C1RT6036	60x36	92	668	1006	1617
	C1RT6636	66x36	102	718	1056	1875
	C1RT7236	72x36	113	761	1098	2053
	C1RT8436	84x36	134	803	1141	2235
	C1RT9636	96x36	156	862	1201	2429

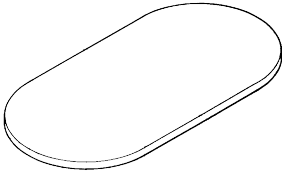

42" DEEP RACE TRACK WORKSURFACE	C1RT8442	84x42	153	862	1201	2316
	C1RT9642	96x42	178	921	1259	2611

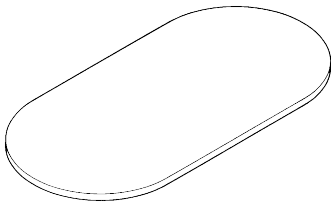

48" DEEP RACE TRACK WORKSURFACE	C1RT8448	84x48	200	948	1286	2611
	C1RT9648	96x48	228	1022	1317	2904

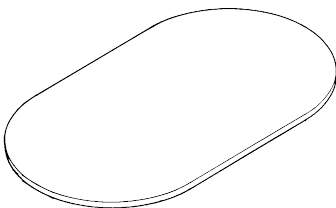



Description	Model No.	Size (A x B x C x D x E)	Wt.	Laminate	Laminate	Veneer
				w/PVC (1)	w/wood (2)	w/wood (3)

### WHITE HOUSE WORKSURFACE

· Refer to "C" dimension below for maximum depth of the Whitehouse Worksurface.  
The length of the short edge is also given as "B" dimension. See the Design and Specification Guide for the specific details and the suggested support elements.

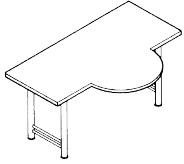

### 18" DEEP WHITE HOUSE WORKSURFACE

C1WH4818	48x18x28x12x24	52	470	807	997
C1WH5418	54x18x29.5x13.5x27	61	481	819	1008
C1WH6018	60x18x31x15x30	69	501	838	1023
C1WH6618	66x18x32.5x16.5x33	78	514	852	1036
C1WH7218	72x18x34x18x36	87	525	863	1045

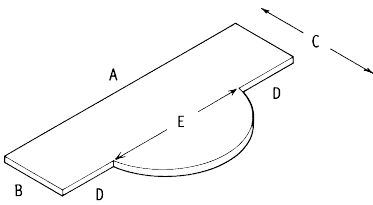

### 20" DEEP WHITE HOUSE WORKSURFACE

C1WH4820	48x20x30x12x24	57	477	816	1006
C1WH5420	54x20x31.5x13.5x27	66	493	831	1017
C1WH6020	60x20x33x15x30	75	508	846	1029
C1WH6620	66x20x34.5x16.5x33	84	522	861	1042
C1WH7220	72x20x36x18x36	94	549	887	1066

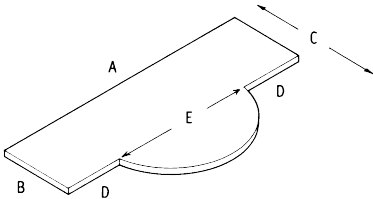

### 24" DEEP WHITE HOUSE WORKSURFACE

C1WH4824	48x24x34x12x24	66	482	821	1009
C1WH5424	54x24x35.5x13.5x27	76	503	842	1027
C1WH6024	60x24x37x15x30	86	514	852	1036
C1WH6624	66x24x38.5x16.5x33	97	529	866	1049
C1WH7224	72x24x40x18x36	108	570	909	1085

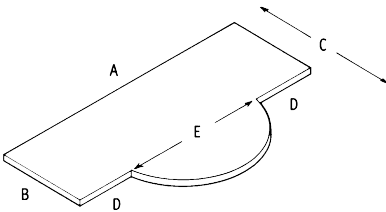

### 30" DEEP WHITE HOUSE WORKSURFACE

C1WH4830	48x30x40x12x24	80	576	912	1088
C1WH5430	54x30x41.5x13.5x27	92	601	940	1113
C1WH6030	60x30x43x15x30	104	624	962	1131
C1WH6630	66x30x44.5x16.5x33	117	652	990	1157
C1WH7230	72x30x46x18x36	129	678	1015	1176

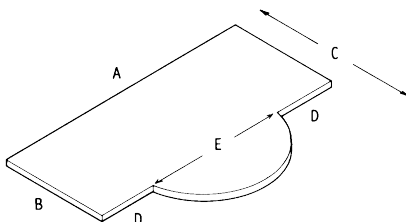

C O U N T E R P O I N T P R I C E L I S T

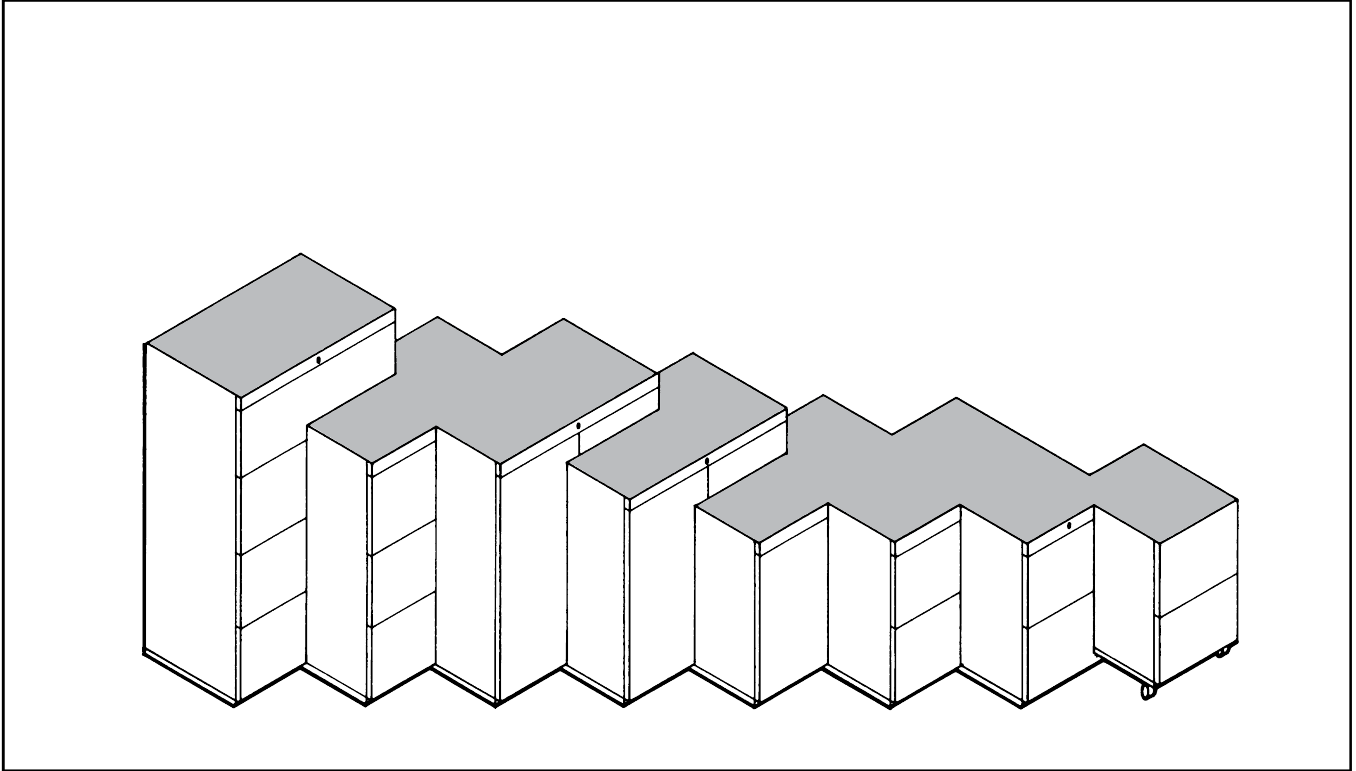

### GENERAL SPECIFICATIONS

- Cases are constructed of  $\frac{3}{4}$ " thick medium density industrial particle board clad with black laminate on both faces.
- Door and drawer faces are available in two optional finishes:
  1. Laminate with 2mm PVC edgeband on 4 edges.
  2. Wood veneer with 2mm wood edge on 4 edges.
- See the Design and Specification Guide for finish selection. (Note: All door and drawer pulls are black powder coated steel.)
- A center mounted lock in the face rail is standard for all lower storage elements except mobile pedestals. Specify keying conditions for locks. Lock core can be shipped separately and may be field installed when required.
- Lower storage units, 42" and 48" wide, have center partitions.
- Optional locks for mobile pedestals are installed in the side of the case.
- Lower storage elements do not include a finished top. When used as a stand alone unit, specify the appropriate top.
- All lower storage elements include leveling glides.

Description	Model No.	Size (WxDxH)	Wt.	Laminate face	Veneer face
PEDESTALS				(1)	(3)

- File drawers are equipped with rails for hanging letter and legal size file folders.
- Box drawer units include one pencil tray per pedestal.
- Storage pedestals include one adjustable shelf.
- Mobile pedestals do not include a finished top. When used as a stand alone unit, specify "Mobile Pedestal Top" (on p. 2-3).
- Mobile pedestal locks are available: specify "Lock for Mobile Pedestal" (on p. 2-3).

PEDESTAL 2 BOX, 1 FILE DRAWER*	C2BB18	15.5x18x27.5	73	806	1027
	C2BB22	15.5x21.5x27.5	80	880	1100

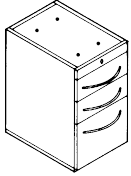

\*See page 2-8 for metal options

PEDESTAL 2 FILE DRAWERS*	C2FF18	15.5x18x27.5	71	806	1026
	C2FF22	15.5x21.5x27.5	78	880	1100

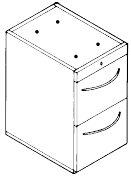

\*See page 2-8 for metal options

PEDESTAL 4 BOX DRAWERS	C2BP18	15.5x18x27.5	77	927	1138
	C2BP22	15.5x21.5x27.5	84	1008	1218

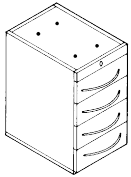

MOBILE PEDESTAL 2 BOX, 1 FILE DRAWER*	C2MB18	15.5x18x27.5	70	863	1073
	C2MB22	15.5x21.5x27.5	77	944	1154

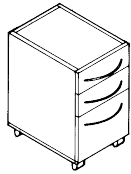

\*See page 2-8 for metal options

MOBILE PEDESTAL 2 FILE DRAWERS*	C2MF18	15.5x18x27.5	68	863	1073
	C2MF22	15.5x21.5x27.5	75	944	1154

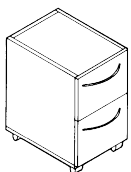

\*See page 2-8 for metal options



Description	Model No.	Size (WxDxH)	Wt.	Laminate	Veneer
				face (1)	face (3)
MOBILE PEDESTAL 4 BOX DRAWERS	C2MP18	15.5x18x27.5	74	904	1114
	C2MP22	15.5x21.5x27.5	81	984	1194



MOBILE PEDESTAL 1 TRAY, 1 BOX, 1 FILE	C2BF18	15.5x18x25.5	70	863	1073
	C2BF22	15.5x22x25.5	77	944	1154

Description	Model No.	Size (WxDxH)	Wt.	Laminate	Laminate	Veneer
				w/PVC (1)	w/wood (2)	w/wood (3)
MOBILE PEDESTAL TOP	C1MT20	15.5x20x1.5	14	132	214	640
	C1MT24	15.5x24x1.5	16	149	230	669

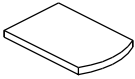

Price Each

LOCK FOR MOBILE PEDESTAL (Specify left or right)	C2ML01		1	62	
---	--------	--	---	----	--



Description	Model No.	Size (WxDxH)	Wt.	Laminate	Veneer
				face (1)	face (3)
STORAGE PEDESTAL HINGED LEFT	C2SP18L	15.5x18x27.5	35	541	752
	C2SP22L	15.5x21.5x27.5	41	566	776

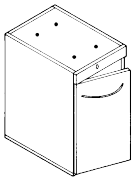

STORAGE PEDESTAL HINGED RIGHT	C2SP18R	15.5x18x27.5	35	541	752
	C2SP22R	15.5x21.5x27.5	41	566	776

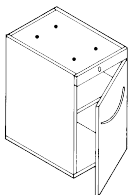

Description	Model No.	Size (WxDxH)	Wt.	Laminate face	Veneer face
LATERAL FILES				(1)	(3)

- All drawers are equipped with rails for side to side and front to back filing of both letter and legal size hanging file folders.
- Anti-tip lockout mechanism is standard in all lateral file units.
- Lateral files do not include a finished top. When used as a stand alone unit, specify the appropriate worksurface.
- Freestanding lateral files need to have (1) C2CW24 counterweight.

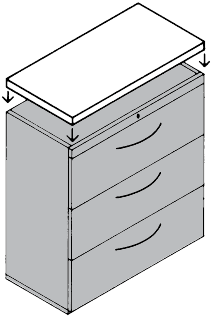

2 DRAWER LATERAL FILE\*

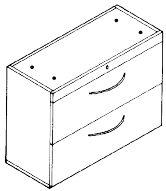

C2LF302D	30x18x27.5	146	1170	1567
C2LF362D	36x18x27.5	175	1243	1611
C2LF422D	42x18x27.5	204	1287	1655

\*See page 2-9 for metal options

3 DRAWER LATERAL FILE\*

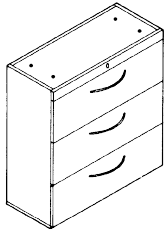

C2LF303D	30x18x40.5	217	1721	2206
C2LF363D	36x18x40.5	260	1771	2258
C2LF423D	42x18x40.5	303	1815	2302

\*See page 2-9 for metal options

4 DRAWER LATERAL FILE\*

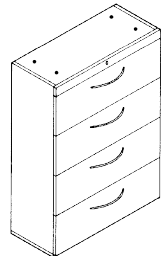

C2LF304D	30x18x51.5	275	2205	2691
C2LF364D	36x18x51.5	330	2258	2743
C2LF424D	42x18x51.5	385	2302	2787

\*See page 2-9 for metal options

COUNTERWEIGHT FOR FREESTANDING FILES

C2CW24	24x8x.5	25	154	
--------	---------	----	-----	--

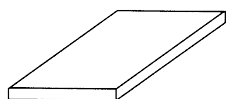

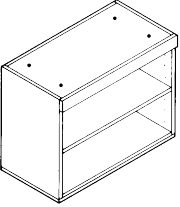
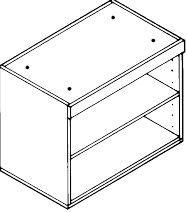
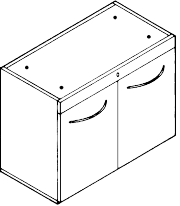
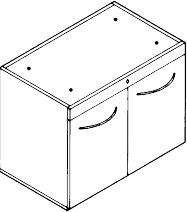
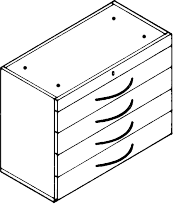
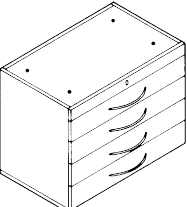
Description	Model No.	Size (WxDxH)	Wt.	Laminate	Veneer	
				face (1)	face (3)	
<b>18" DEEP LOW STORAGE OPEN</b> 	C2LS2418O	24x18x27.5	82	396	428	
	C2LS3018O	30x18x27.5	96	445	477	
	C2LS3618O	36x18x27.5	110	486	519	
	C2LS4218O	42x18x27.5	123	534	566	
	C2LS4818O	48x18x27.5	136	582	614	
<b>22" DEEP LOW STORAGE OPEN</b> 	C2LS2422O	24x21.5x27.5	84	413	445	
	C2LS3022O	30x21.5x27.5	99	460	493	
	C2LS3622O	36x21.5x27.5	113	502	534	
	C2LS4222O	42x21.5x27.5	127	550	582	
	C2LS4822O	48x21.5x27.5	140	631	652	
<b>18" DEEP LOW STORAGE W/DOOR(S)</b> 	C2LS2418D	24x18x27.5	101	687	849	
	(24" W units have 1 door — Specify left or right hinged)					
	C2LS3018D	30x18x27.5	119	890	1132	
	C2LS3618D	36x18x27.5	138	971	1214	
	C2LS4218D	42x18x27.5	155	1042	1286	
C2LS4818D	48x18x27.5	173	1108	1350		
<b>22" DEEP LOW STORAGE W/DOOR(S)</b> 	C2LS2422D	24x21.5x27.5	103	703	865	
	(24" W units have 1 door — Specify left or right hinged)					
	C2LS3022D	30x21.5x27.5	107	922	1148	
	C2LS3622D	36x21.5x27.5	141	1004	1230	
	C2LS4222D	42x21.5x27.5	160	1059	1302	
C2LS4822D	48x21.5x27.5	177	1124	1367		
<b>18" DEEP LOW STORAGE 4 DRAWERS</b> 	C2LS24184D	24x18x27.5	108	1252	1496	
	C2LS30184D	30x18x27.5	128	1302	1554	
	C2LS36184D	36x18x27.5	148	1342	1602	
<b>22" DEEP LOW STORAGE 4 DRAWERS</b> 	C2LS24224D	24x21.5x27.5	118	1269	1512	
	C2LS30224D	30x21.5x27.5	140	1318	1569	
	C2LS36224D	36x21.5x27.5	163	1358	1617	

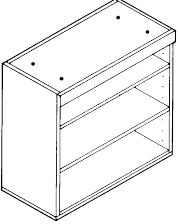
Description	Model No.	Size (WxDxH)	Wt.	Laminate face	Veneer face
				(1)	(3)
<b>18" DEEP MIDDLE STORAGE OPEN</b> 	C2MS2418O	24x18x34.5	85	437	470
	C2MS3018O	30x18x34.5	99	493	525
	C2MS3618O	36x18x34.5	113	534	566
	C2MS4218O	42x18x34.5	127	590	622
	C2MS4818O	48x18x34.5	142	640	673

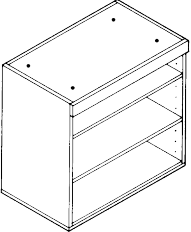
<b>22" DEEP MIDDLE STORAGE OPEN</b> 	C2MS2422O	24x21.5x34.5	100	453	486
	C2MS3022O	30x21.5x34.5	116	509	541
	C2MS3622O	36x21.5x34.5	132	550	582
	C2MS4222O	42x21.5x34.5	149	607	638
	C2MS4822O	48x21.5x34.5	165	655	687

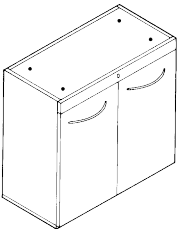
<b>18" DEEP MIDDLE STORAGE W/DOOR(S)</b> 	C2MS2418D	24x18x34.5	103	739	1098	
	(24" W units have 1 door — Specify left or right hinged)					
	C2MS3018D	30x18x34.5	122	978	1246	
	C2MS3618D	36x18x34.5	141	1067	1334	
	C2MS4218D	42x18x34.5	160	1148	1414	
C2MS4818D	48x18x34.5	178	1220	1488		

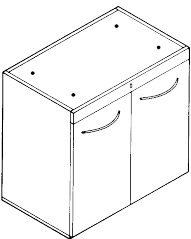
<b>22" DEEP MIDDLE STORAGE W/DOOR(S)</b> 	C2MS2422D	24x21.5x34.5	118	768	1128	
	(24" W units have 1 door — Specify left or right hinged)					
	C2MS3022D	30x21.5x34.5	140	995	1262	
	C2MS3622D	36x21.5x34.5	160	1084	1350	
	C2MS4222D	42x21.5x34.5	181	1164	1430	
C2MS4822D	48x21.5x34.5	202	1237	1504		

Description	Model No.	Size (WxDxH)	Wt.	Laminate face	Veneer face
				(1)	(3)
18" DEEP HIGH STORAGE OPEN	C2HS2418O	24x18x40.5	93	477	509
	C2HS3018O	30x18x40.5	108	541	575
	C2HS3618O	36x18x40.5	123	582	614
	C2HS4218O	42x18x40.5	137	638	670
	C2HS4818O	48x18x40.5	153	712	744

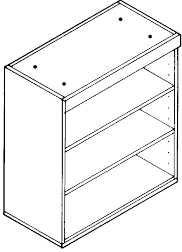

22" DEEP HIGH STORAGE OPEN	C2HS2422O	24x21.5x40.5	101	493	525
	C2HS3022O	30x21.5x40.5	118	558	590
	C2HS3622O	36x21.5x40.5	135	599	638
	C2HS4222O	42x21.5x40.5	152	655	687
	C2HS4822O	48x21.5x40.5	170	729	761

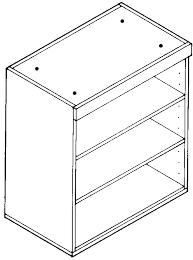

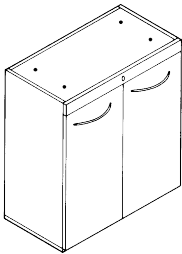

18" DEEP HIGH STORAGE W/DOOR(S)	C2HS2418D	24x18x40.5	115	800	1027	
	(24" W units have 1 door — Specify left or right hinged)					
	C2HS3018D	30x18x40.5	135	1075	1375	
	C2HS3618D	36x18x40.5	155	1172	1462	
	C2HS4218D	42x18x40.5	176	1262	1544	
C2HS4818D	48x18x40.5	196	1342	1586		

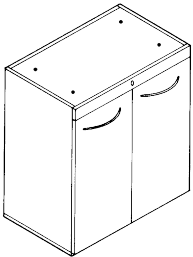

22" DEEP HIGH STORAGE W/DOOR(S)	C2HS2422D	24x21.5x40.5	123	817	1042	
	(24" W units have 1 door — Specify left or right hinged)					
	C2HS3022D	30x21.5x40.5	144	1091	1392	
	C2HS3622D	36x21.5x40.5	166	1188	1480	
	C2HS4222D	42x21.5x40.5	187	1278	1560	
C2HS4822D	48x21.5x40.5	208	1358	1602		

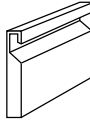
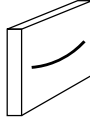
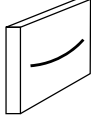
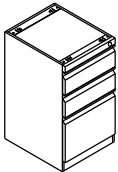
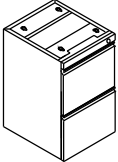

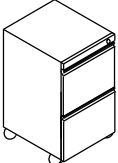
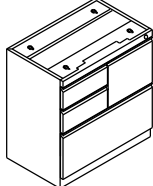
Description	Model No.	Size (WxDxH)	Metal face	Laminate face	Veneer face
<b>METAL PEDESTALS</b>			(4)	(5)	(6)
<ul style="list-style-type: none"> <li>· All steel welded construction.</li> <li>· Fully assembled and texture painted (black standard).</li> <li>· Inverted j-pull on metal faces, standard counterpoint pull on laminate and veneer faces.</li> <li>· 3/4 extension roller slides on 6" box drawers.</li> <li>· Full extension steel ball bearing slides on all 12" file drawers.</li> <li>· Top box drawer includes pencil tray.</li> <li>· Gang locking using master keyed, core removable locks.</li> <li>· Integrated base with leveling glides.</li> <li>· Mobile pedestals include counterweight, finished metal top, and 4 casters; 2 locking and 2 non-locking.</li> </ul>					
<b>PEDESTAL 2 BOX, 1 FILE DRAWER</b>	C2BB18	15x18x27.75*	670	849	1039
	C2BB22	15x22x27.75	684	891	1082
	C2BB28	15x28x27.75	759	938	1128
(worksurface supporting)					
<b>PEDESTAL 2 FILE DRAWERS</b>	C2FF18	15x18x27.75	597	764	953
	C2FF22	15x22x27.75	603	770	960
	C2FF28	15x28x27.75	679	845	1041
(worksurface supporting)					
<b>MOBILE PEDESTAL 2 BOX, 1 FILE DRAWER</b>	C2MB18	15x18x27.75*	803	976	1410
	C2MB22	15x22x27.75	810	983	1416
	C2MB28	15x28x27.75	898	1071	1510
<b>MOBILE PEDESTAL 2 FILE DRAWERS</b>	C2MF18	15x18x27.75	742	915	1348
	C2MF22	15x22x27.75	747	926	1360
	C2MF28	15x28x27.75	818	1071	1429
<b>MULTI-PEDESTAL 2 BOX, 1 FILE, 1 LATERAL FILE</b>	C2FC30	30.5x18.5x27.75	1276	1544	1829
					

(worksurface supporting)

\*sizes are nominal, contact factory for exact size

Description	Model No.	Size (WxDxH)	Metal face (4)	Laminate face (5)	Veneer face (6)
-------------	-----------	--------------	-------------------	----------------------	--------------------

2 DRAWER LATERAL FILE

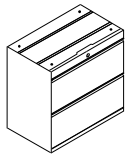

C2FC302D	30.5x18.5x27.75	978	1186	1471
C2FC362D	36x18.5x27.75	1044	1270	1555
C2FC422D	N/A	N/A	N/A	N/A

(worksurface supporting)

2 DRAWER LATERAL FILE

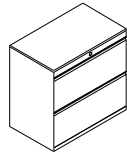

C2LF302D	30x18x27.75	1093	1218	1446
C2LF362D	36x18x27.75	1188	1337	1566
C2LF422D	42x18x27.75	1301	1461	1690

(free-standing/finished top)

3 DRAWER LATERAL FILE



C2LF303D	30x18x40	1389	1573	1920
C2LF363D	36x18x40	1559	1767	2115
C2LF423D	42x18x40	1729	1955	2302

(free standing/finished top)

4 DRAWER LATERAL FILE

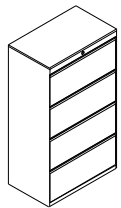

C2LF304D	30x18x52	1734	1966	2313
C2LF364D	36x18x52	1935	2103	2449
C2LF424D	42x18x52	2130	2329	2676

(free standing/finished top)

5 DRAWER LATERAL FILE

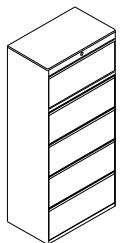

C2LF305D	30x18x64	2193	2406	2923
C2LF365D	36x18x64	2445	2700	3217
C2LF425D	42x18x64	2727	3072	3529

(free standing/finished top, flipper door with retractable bin on top)

C O U N T E R P O I N T P R I C E L I S T



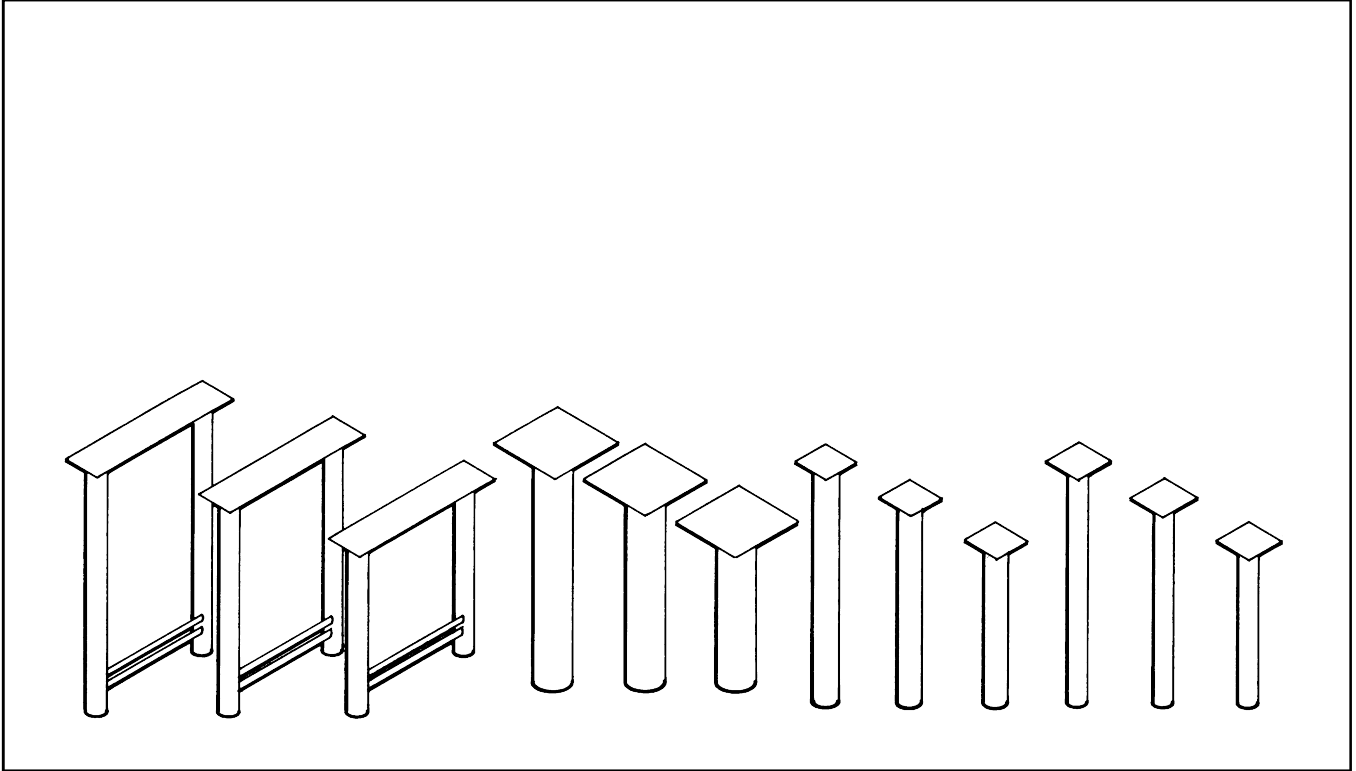

#### GENERAL SPECIFICATIONS

- Support elements are black powder coated steel tubes welded to  $\frac{1}{8}$ " steel plates.
- All units, except table bases TB22, TB26, and TB32 include leveling glides in bases.
- Adjustable legs range in height from 24.5" to 28.5" to allow worksurface heights from 26" to 30".
- Support elements are attached to worksurfaces with standard machine bolts into metal inserts. See the Design and Specification Guide for standard placement of support elements. Specify non standard locations for support elements when ordering custom configurations.

Description	Model No.	Size (WxDxH)	Wt.	Price Each
SUPPORT LEG 3" DIAMETER	C3SL3D27	3" DIAx27.5	8	227
	C3SL3D34	3" DIAx34.5	10	305
	C3SL3D40	3" DIAx40.5	12	305



SUPPORT LEG 3" DIAMETER, ADJUSTABLE	C3SL3DA27	3" DIAx24.5 to 28.58		273
--	-----------	----------------------	--	-----



SUPPORT LEG 4" DIAMETER	C3SL4D27	4" DIAx27.5	10	234
	C3SL4D34	4" DIAx34.5	13	312
	C3SL4D40	4" DIAx40.5	16	312



SUPPORT LEG 4" DIAMETER, ADJUSTABLE	C3SL4DA27	4" DIAx24.5 to 28.510		281
--	-----------	-----------------------	--	-----



SUPPORT LEG 6" DIAMETER	C3SL6D27	6" DIAx27.5	21	382
	C3SL6D34	6" DIAx34.5	27	615
	C3SL6D40	6" DIAx40.5	32	615

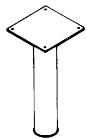

3

LOWER SUPPORT

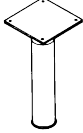
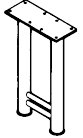
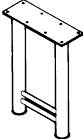
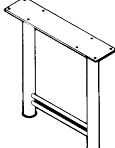
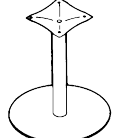
Description	Model No.	Size (WxDxH)	Wt.	Price Each
SUPPORT LEG 6" DIAMETER, ADJUSTABLE	C3SL6DA27	6" DIAx24.5 to 28.521		429
				
DOUBLE SUPPORT LEG 14" WIDE (6"x16" PLATE)	C3DL1427	14x3x27.5	15	362
	C3DL1434	14x3x34.5	20	525
	C3DL1440	14x3x40.5	23	525
				
DOUBLE SUPPORT LEG 17" WIDE (6"x18" PLATE)	C3DL1727	16.25x3x27.5	17	369
	C3DL1734	16.25x3x34.5	22	532
	C3DL1740	16.25x3x40.5	25	532
				
DOUBLE SUPPORT LEG 23" WIDE (6"x26" PLATE)	C3DL2327	23x3x27.5	19	378
	C3DL2334	23x3x34.5	23	545
	C3DL2340	23x3x40.5	28	545
				
TABLE BASE	C3TB22	22" DIA (for tops from 30" to 42" in diameter)	61	461
	C3TB26	26" DIA (for tops 48" in diameter)	92	616
	C3TB32	32" DIA (for tops from 54" to 60" in diameter)	149	716

Description	Model No.	Size (WxDxH)	Price Each
-------------	-----------	--------------	------------

MOBILE SUPPORT LEG – LOCKING  
3" DIAMETER

C3ML3D27	3" DIAx27.5	256
C3ML3D34	3" DIAx34.5	333
C3ML3D40	3" DIAx40.5	333

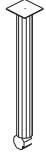

MOBILE SUPPORT LEG – LOCKING  
4" DIAMETER

C3ML4D27	4" DIAx27.5	256
C3ML4D34	4" DIAx34.5	333
C3ML4D40	4" DIAx40.5	333



MOBILE DOUBLE SUPPORT LEG  
LOCKING - 14" WIDE

C3MD1427	14"x27.5	432
----------	----------	-----

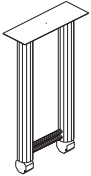

MOBILE DOUBLE SUPPORT LEG  
LOCKING - 17" WIDE

C3MD1727	17"x27.5	440
----------	----------	-----

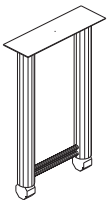

MOBILE DOUBLE SUPPORT LEG  
LOCKING - 23" WIDE

C3MD2327	23"x27.5	461
----------	----------	-----

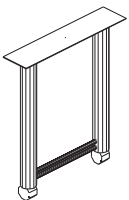

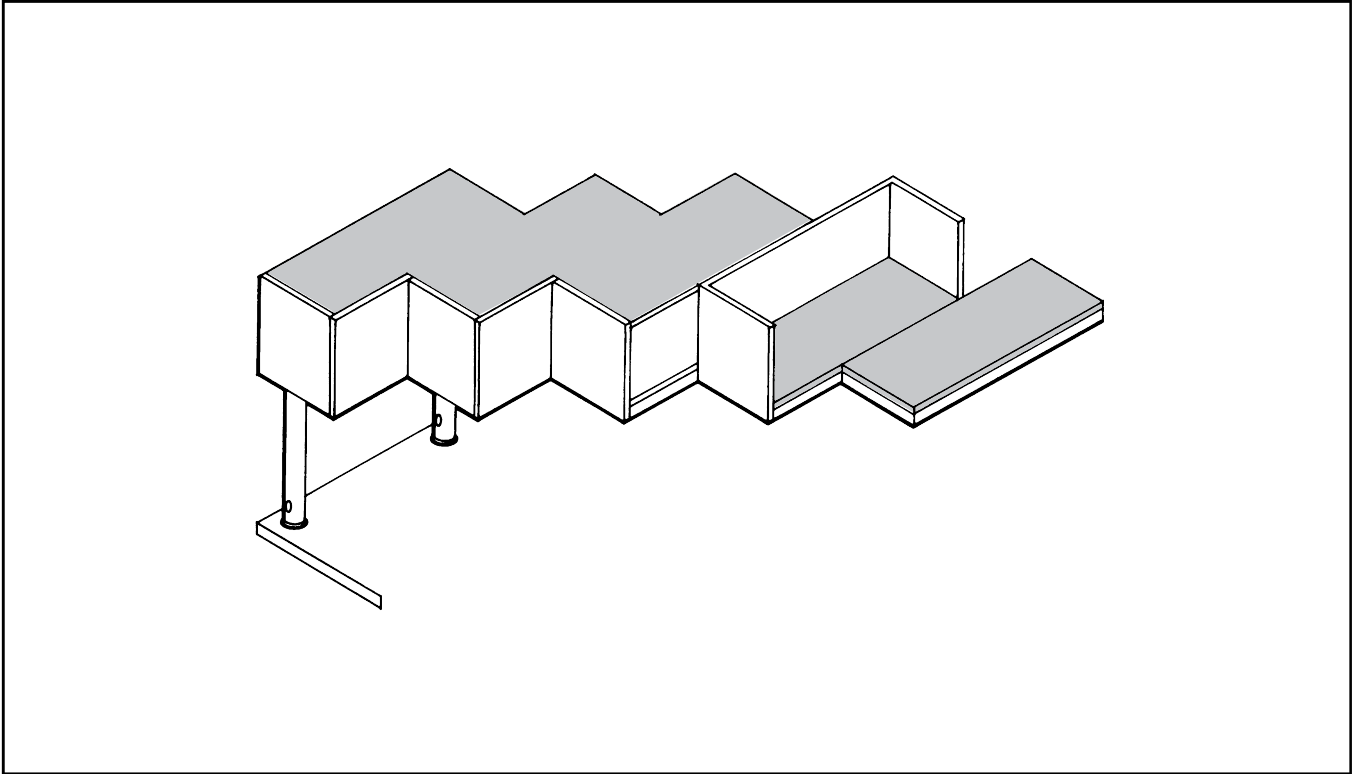

#### GENERAL SPECIFICATIONS

- All upper storage element cases are constructed of  $\frac{3}{4}$ " black laminate clad industrial particle board.
- All units include two upper support posts with each item.
- Upper storage units are mounted to the worksurfaces by standard machine bolts through wire access holes at each end of the unit. Worksurfaces should correspond to the length of the overhead unit. Specify which worksurfaces will require machining for mounting the upper storage elements.
- The bottom shelf includes inserts for mounting support posts.
- Units to 54" wide accept 24" wide task lights (C7TL24). Units 60", 66" and 72" wide accept 48" wide task lights (C7TL48).
- Support posts include two wire access holes at top and two at base for managing data/com/electrical wires. Wires pass through the supports and exit below the worksurfaces.
- Locks for upper storage elements are optional and must be specified with order. Include keying information if required.

Description	Model No.	Size (WxDxH)	Wt.	Price Each
-------------	-----------	--------------	-----	------------

**UPPER FLAT SHELF**

Unit cannot be wall mounted

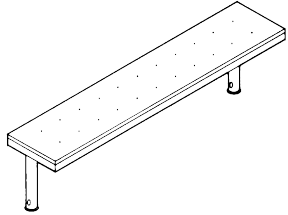

C4FS30	30x15x3	38	574
C4FS36	36x15x3	41	603
C4FS42	42x15x3	44	618
C4FS48	48x15x3	47	647
C4FS54	54x15x3	50	691
C4FS60	60x15x3	53	704
C4FS66	66x15x3	56	724
C4FS72	72x15x3	59	742

**UPPER STORAGE SHELF**

For wall mount application, deduct \$418

from price of upper storage unit, and add

a "W" to the model number (ex: C4SS60W).

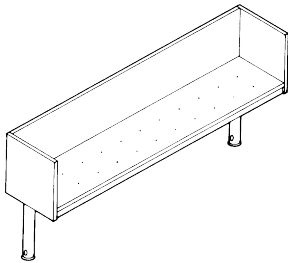

C4SS30	30x15x16	54	764
C4SS36	36x15x16	59	794
C4SS42	42x15x16	64	808
C4SS48	48x15x16	69	845
C4SS54	54x15x16	74	867
C4SS60	60x15x16	79	889
C4SS66	66x15x16	84	901
C4SS72	72x15x16	89	911

**UPPER STORAGE - OPEN**

For wall mount application, deduct \$418

from price of upper storage unit, and add a

"W" to the model number (ex: C4SO60W).

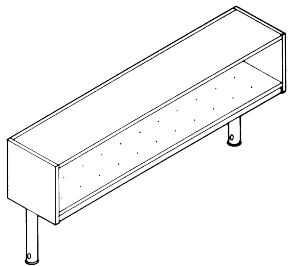

C4SO30	30x15x16	56	778
C4SO36	36x15x16	61	808
C4SO42	42x15x16	66	822
C4SO48	48x15x16	71	860
C4SO54	54x15x16	76	889
C4SO60	60x15x16	81	911
C4SO66	66x15x16	86	923
C4SO72	72x15x16	91	932

UPPER STORAGE

Description	Model No.	Size (WxDxH)	Wt.	Laminate Face (1)	Veneer Face (3)
<b>UPPER STORAGE WITH HINGED DOORS</b>					
<ul style="list-style-type: none"> <li>· 30", 36" and 42" wide units include 2 doors.</li> <li>· 48" and 54" wide units include 3 doors with interior partition on the right side for mounting the center door.</li> <li>· 60", 66" and 72" wide units have 4 doors. Units have interior center partition for mounting the center doors.</li> <li>· Door faces are available in two optional finishes:                             <ol style="list-style-type: none"> <li>1. Laminate with 2mm PVC edgeband on 4 sides.</li> <li>2. Wood veneer with 2mm wood edge on 4 sides.</li> </ol> </li> <li>· See the Design and Specification Guide for finish selection.</li> <li>· To determine the price for wall mounted option, deduct \$418 from price of upper storage unit, and add a "W" to the model number (ex: C4SH48W).</li> </ul>					

**UPPER STORAGE - HINGED DOOR**

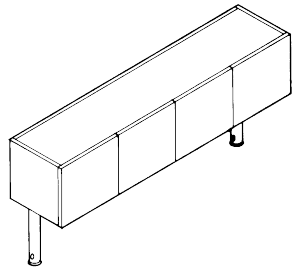

C4SH30	30x15x16	68	963	1110
C4SH36	36x15x16	75	1007	1154
C4SH42	42x15x16	83	1051	1198
C4SH48	48x15x16	91	1228	1374
C4SH54	54x15x16	98	1323	1624
C4SH60	60x15x16	106	1447	1742
C4SH66	66x15x16	114	1484	1779
C4SH72	72x15x16	121	1521	1815

UPPER STORAGE

**UPPER STORAGE WITH FLIPPER DOORS**

- 30", 36" and 42" wide units include one door.
- Units 48" and wider have two doors. These units include an interior partition at the center of the opening.
- Flipper doors retract over the top of the unit case.
- Door faces are available in two optional finishes:
  1. Laminate with 2mm PVC edgeband on 4 sides.
  2. Wood veneer with 2mm wood edge on 4 sides.
- See the Design and Specification Guide for finish selection.
- To determine the price for wall mounted option, deduct \$418 from price of upper storage unit, and add a "W" to the model number (ex: C4SF48W).

**UPPER STORAGE - FLIPPER DOOR**

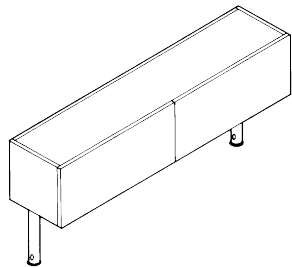

C4SF30	30x15x16	68	963	1110
C4SF36	36x15x16	75	1007	1154
C4SF42	42x15x16	83	1051	1198
C4SF48	48x15x16	91	1228	1374
C4SF54	54x15x16	98	1323	1624
C4SF60	60x15x16	106	1447	1742
C4SF66	66x15x16	114	1484	1779
C4SF72	72x15x16	121	1521	1815

Description	Model No.	Size (WxDxH)	Wt.	Price Each
-------------	-----------	--------------	-----	------------

**UPPER STORAGE - BOOKCASE**

- For wall mounted application, deduct 394 from price of upper storage unit, and add a "W" to the model number (ex. C4OB30W).
- Units must be attached to wall, with or without posts. Appropriate method to be decided upon in field.
- 48" H units receive (2) adjustable shelves.
- 54" H units receive (3) adjustable shelves.
- 60" H units receive (4) adjustable shelves.

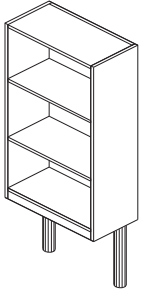

C4OB3048	30x48	99	962
C4OB3648	36x48	111	1029
C4OB4248	42x48	135	1040
C4OB4848	48x48	147	1235
C4OB3054	30x54	105	1029
C4OB3654	36x54	117	1114
C4OB4254	42x54	142	1303
C4OB4854	48x54	153	1357
C4OB3060	30x60	111	1081
C4OB3660	36x60	123	1116
C4OB4260	42x60	148	1353
C4OB4860	48x60	158	1423

UPPER STORAGE

**WIRE SHELF DIVIDER**

C4SD50	5x7	1	5
--------	-----	---	---



**OVERHEAD SUPPORT POST PAIR\*  
(Not sold separately)**

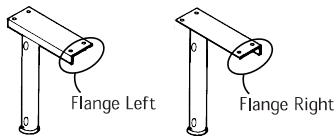

C4UP20	3" DIAx20	12	418 Per Pair
C4UP22	3" DIAx22	13	461 Per Pair
C4UP24	3" DIAx24	14	502 Per Pair
C4UP26	3" DIAx26	15	545 Per Pair

\*consult factory for appropriate screens and pricing

**TRANSACTION TOP  
SUPPORT POST PAIR  
(Not sold separately)**

C4UP11	3" DIAx11.5	8	362 Per Pair
--------	-------------	---	--------------

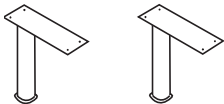



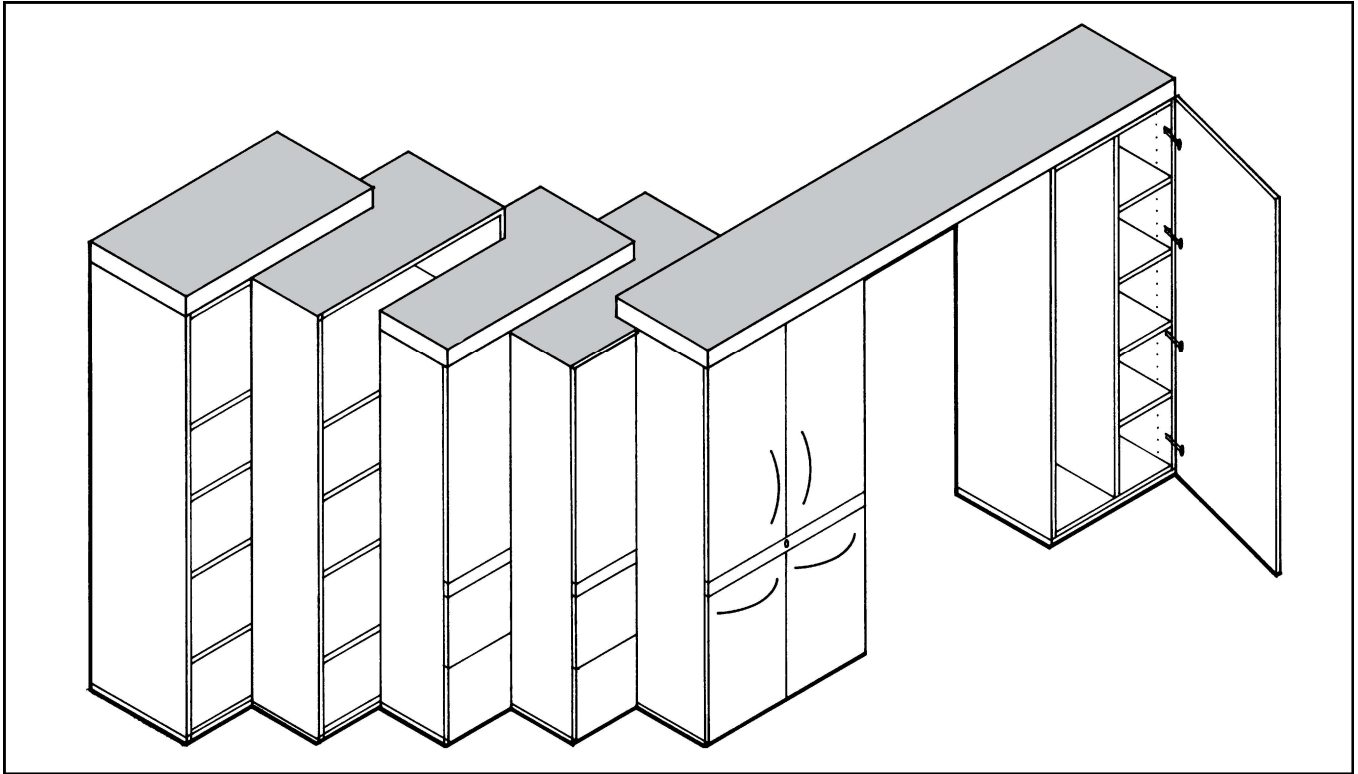

#### GENERAL SPECIFICATIONS

- Cases are constructed of  $\frac{3}{4}$ " thick medium density industrial particle board clad with black laminate on both faces.
- Door and drawer faces are available in two optional finishes:
  1. Laminate with 2mm PVC edgeband on 4 edges.
  2. Wood veneer with 2mm wood edgeband on 4 edges.
- See the Design and Specification Guide for finish selections.
- Locks are available as an option for all upper portions of the towers. A center mounted lock is standard on all units with lock rails. Specify keying conditions for locks. Lock core can be shipped separately for field installation.

Description	Model No.	Size (WxDxH)	Wt.	Price Each
-------------	-----------	--------------	-----	------------

**BOOKCASE TOWER**

- The interior and exterior of bookcases are black laminate.
- The center shelf is fixed at 27.5" A.F.F.
- Shelf adjustment holes are 32mm on center.

**63" BOOKCASE TOWER\***

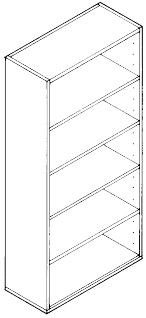

C5OB301263	30x12x63	147	768
C5OB302063	30x20x63	192	849
C5OB361263	36x12x63	160	800
C5OB362063	36x20x63	206	880

**72" BOOKCASE TOWER\***

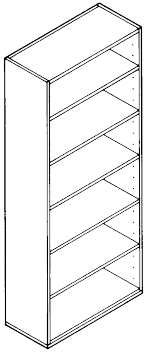

C5OB301272	30x12x72	170	865
C5OB302072	30x20x72	218	930
C5OB361272	36x12x72	183	897
C5OB362072	36x20x72	234	971

5

Description	Model No.	Size (WxDxH)	Wt.	Laminate Face	Veneer Face
STORAGE TOWER				(1)	(3)
<ul style="list-style-type: none"> <li>· Locks for lower storage are standard.</li> <li>· Center shelf is fixed at 27.5" A.F.F.</li> <li>· Specify finish for the doors and lock rail. See the Design and Specification Guide for finish selection.</li> </ul>					

63" STORAGE TOWER  
W/LOWER DOORS

C5DO302063	30x20x63	190	1375	1698
C5DO302463	30x24x63	216	1430	1754
C5DO362063	36x20x63	217	1407	1712
C5DO362463	36x24x63	247	1462	1787

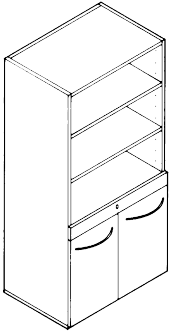

72" STORAGE TOWER  
W/LOWER DOORS

C5DO302072	30x20x72	203	1456	1779
C5DO302472	30x24x72	231	1536	1859
C5DO362072	36x20x72	232	1496	1819
C5DO362472	36x24x72	263	1577	1900

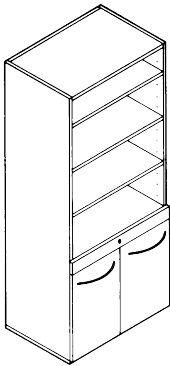

BUILDING TOWERS

Description	Model No.	Size (WxDxH)	Wt.	Laminate Face	Veneer Face
STORAGE TOWER WITH 4 DOORS				(1)	(3)

- Locks for the lower section are standard. Upper sections are available with an optional lock. See Section 7 for ordering and keying information.
- Specify finish for the doors and lock rail. See the Design and Specification Guide for finish selections.
- Units contain one fixed shelf at the top of the lock rail at 27.5" A.F.F. 63" high towers have 1 adjustable shelf in the lower section and 2 in the upper section. 72" high towers have 1 adjustable shelf in the lower section and 3 in the upper section.

63" STORAGE TOWER WITH 4 DOORS

C5DD302063	30x20x63	213	1980	2627
C5DD302463	30x24x63	239	2038	2686
C5DD362063	36x20x63	244	2013	2660
C5DD362463	36x24x63	274	2070	2717

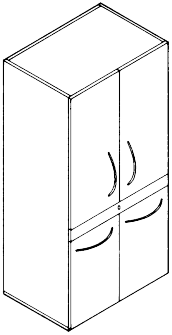

72" STORAGE TOWER WITH 4 DOORS

C5DD302072	30x20x72	232	2062	2708
C5DD302472	30x24x72	260	2142	2790
C5DD362072	36x20x72	266	2104	2749
C5DD362472	36x24x72	297	2184	2831

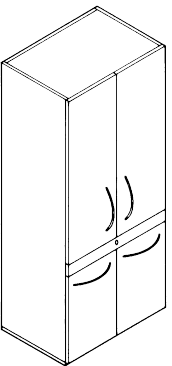

Description	Model No.	Size (WxDxH)	Wt.	Laminate Face	Veneer Face
<b>FILE TOWER WITH OPEN STORAGE</b>				(1)	(3)
<ul style="list-style-type: none"> <li>· Specify the finish for drawer fronts and lock rail. See the Design and Specification Guide for finish selections.</li> <li>· Drawers are equipped with rails for hanging file folders.</li> <li>· Lock rails align with lock rails in lower storage elements at 27<sup>1</sup>/<sub>4</sub>" A.F.F.</li> <li>· 63" high units include 2 adjustable shelves. 72" high units include 3 adjustable shelves.</li> </ul>					

**63" FILE TOWER WITH OPEN STORAGE**

C5OL302063	30x20x63	231	1812	2136
C5OL302463	30x24x63	257	1868	2192
C5OL362063	36x20x63	265	1844	2167
C5OL362463	36x24x63	294	1900	2224

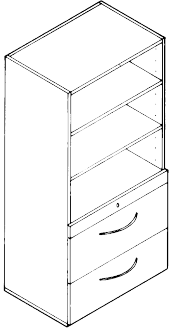

**72" FILE TOWER WITH OPEN STORAGE**

C5OL302072	30x20x72	244	1892	2216
C5OL302472	30x24x72	272	1974	2297
C5OL362072	36x20x72	279	1932	2255
C5OL362472	36x24x72	310	2013	2336

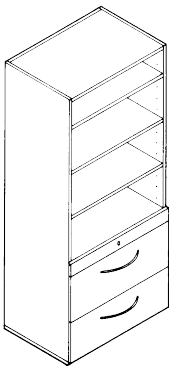

BUILDING TOWERS

Description	Model No.	Size (WxDxH)	Wt.	Laminate Face	Veneer Face
<b>FILE TOWER WITH DOORS</b>				(1)	(3)
<ul style="list-style-type: none"> <li>· Specify the finish for doors, drawer fronts and lock rail. See the Design and Specification Guide for finish selections.</li> <li>· Optional lock is available for doors. See Section 7 for ordering and keying information.</li> <li>· 63" high units include 2 adjustable shelves. 72" high units include 3 adjustable shelves.</li> </ul>					

**63" FILE TOWER W/DOORS**

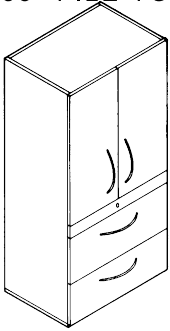

C5DL302063	30x20x63	254	2417	3064
C5DL302463	30x24x63	280	2475	3121
C5DL362063	36x20x63	291	2450	3096
C5DL362463	36x24x63	321	2507	3153

**72" FILE TOWER W/DOORS**

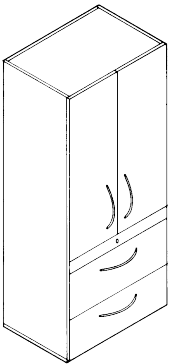

C5DL302072	30x20x72	273	2499	3145
C5DL302472	30x24x72	301	2580	3226
C5DL362072	36x20x72	313	2539	3187
C5DL362472	36x24x72	344	2620	3267

5

Description	Model No.	Size (WxDxH)	Wt.	Laminate Face	Veneer Face
WARDROBE/STORAGE				(1)	(3)

Specify the finish for doors. See the Design and Specification Guide for finish selections.  
 · Optional locks are available. See Section 7 for ordering and keying information.  
 · A 24" wide Wardrobe/Storage Tower has one door. Units 30" and 36" wide have 2 doors.

63" WARDROBE/STORAGE TOWER

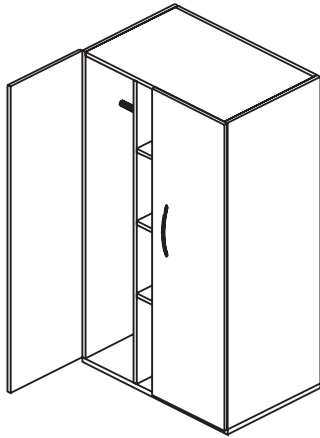

C5WS242463	24x24x63	216	2189	2675
(24" W units have (1) door - specify left or right hinged)				
C5WS302463	30x24x63	252	2263	2748
C5WS362463	36x24x63	289	2438	2813

BUILDING TOWERS

72" WARDROBE/STORAGE TOWER

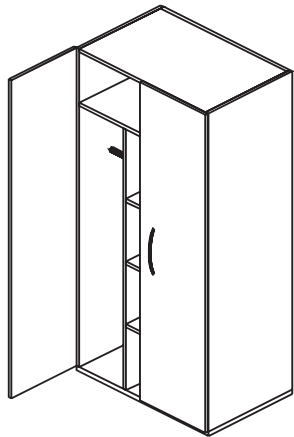

C5WS242472	24x24x72	251	2345	2830
(24" W units have (1) door - specify left or right hinged)				
C5WS302472	30x24x72	294	2417	2903
C5WS362472	36x24x72	337	2490	2975

Description	Model No.	Size (WxDxH)	Wt.	Laminate Face	Veneer Face
<b>FULL STORAGE TOWER</b>				(1)	(3)

- Specify the finish for doors. See the Design and Specification Guide for finish selections.
- Optional locks are available. See Section 7 for ordering and keying information.
- A 24" wide Wardrobe Storage Tower has one door. Units 30" and 36" wide have 2 doors.

**63" STORAGE TOWER**

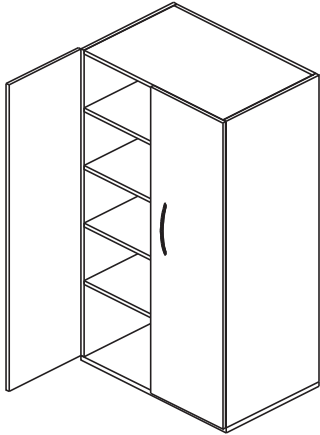

C5ST242463	24x24x63	204	2006	2653
(24" W units have (1) door - specify left or right hinged)				
C5ST302463	30x24x63	239	2038	2686
C5ST362463	36x24x63	274	2070	2717

**72" STORAGE TOWER**

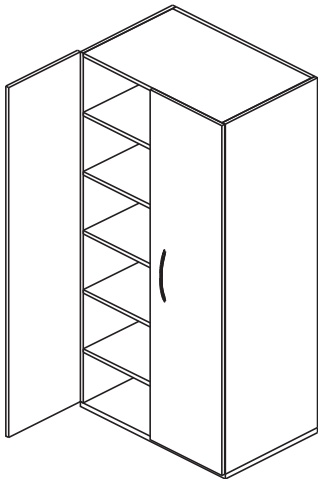

C5ST242472	24x24x72	223	2100	2758
(24" W units have (1) door - specify left or right hinged)				
C5ST302472	30x24x72	260	2142	2790
C5ST362472	36x24x72	297	2184	2831



5

Description	Model No.	Size (WxDxH)	Wt.	Laminate Face	Veneer Face
WARDROBE				(1)	(3)

Specify the finish for doors. See the Design and Specification Guide for finish selections.  
 · Optional locks are available. See Section 7 for ordering and keying information.  
 · A 24" wide Wardrobe Tower has one door. Units 30" and 36" wide have 2 doors.

63" WARDROBE TOWER

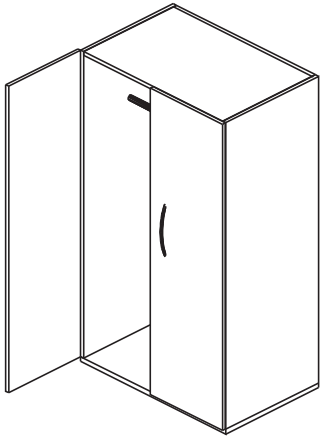

C5WT242463	24x24x63	216	1770	2255
(24" W units have (1) door - specify left or right hinged)				
C5WT302463	30x24x63	252	1812	2297
C5WT362463	36x24x63	289	1844	2329

BUILDING TOWERS

72" WARDROBE TOWER

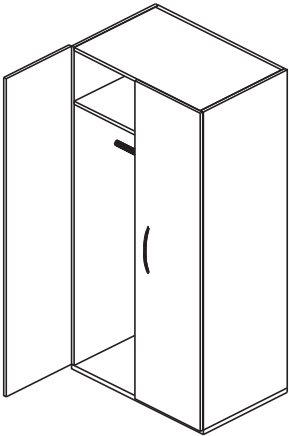

C5WT242472	24x24x72	251	1852	2336
(24" W units have (1) door - specify left or right hinged)				
C5WT302472	30x24x72	294	1892	2378
C5WT362472	36x24x72	337	1932	2417

Description	Model No.	Size (WxDxH)	Metal face	Laminate face	Veneer face
METAL STORAGE TOWER			(4)	(5)	(6)

- All steel welded construction.
- Fully assembled and texture painted (black standard).
- Inverted j-pull on metal faces, standard counterpoint pull on laminate and veneer faces.
- Full extension steel ball bearing slides on all 12" file drawers.
- Gang locking using master keyed, core removable locks.
- Integrated base with leveling glides.

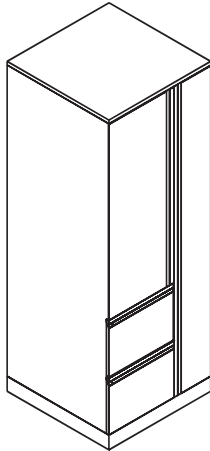

(C5MT6424L shown here)

C5MT6424L	23.5x23.5x64	2763	3054	3190
C5MT6424R	23.5x23.5x64	2763	3054	3190

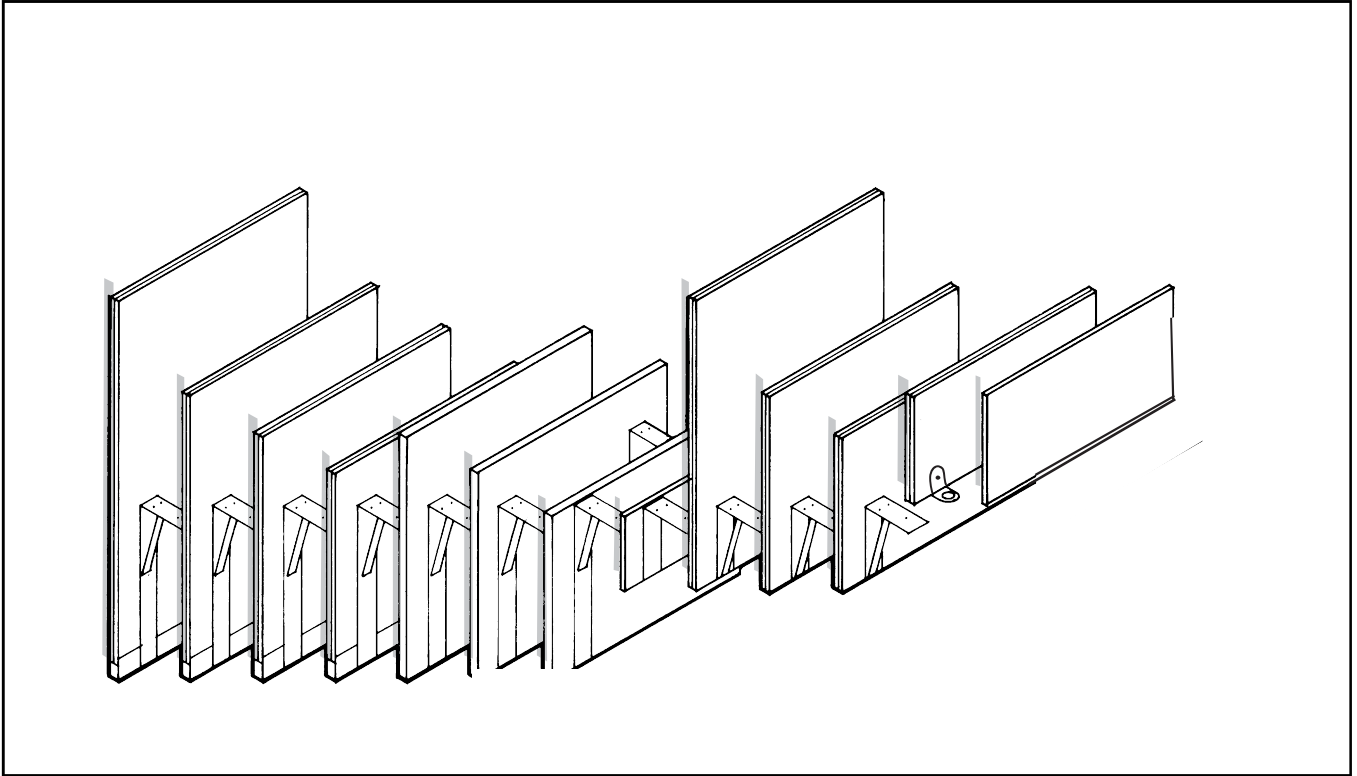

### GENERAL SPECIFICATIONS

- Fabric covered panels are constructed with a hardboard center panel and faced with  $\frac{1}{2}$ " tackable Micore™. Screens are finished on both faces and all edges.
- Tack Panels are finished on the face side only.
- CounterPoint fabric is included in the price. See the Design and Specification Guide for fabric selections. COM yardage requirements are given in the Price List. CounterPoint reserves the right to approve all COM fabrics. Send samples to the factory for evaluation prior to ordering COM fabric.
- All metal components and hardware are finished with black powder coat.
- Mounting hardware is included with the screen.

Description	Model No.	Size (WxDxH)	COM Requirements (YDS)	Wt.	Price Each
-------------	-----------	--------------	------------------------	-----	------------

**SURFACE MOUNTED PRIVACY SCREENS**

- Surface Mounted Privacy Screens are attached to the worksurfaces with brackets mounted through wire access holes. Specify the locations of privacy screens when placing an order to insure proper machining of worksurfaces.
- Mounting brackets include grommet caps and can be used for wire management at the bracket locations.

**SURFACE MOUNTED SCREEN**

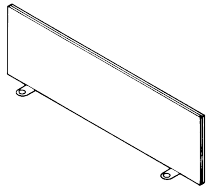

C6PS2018	20x1.25x18	1.5	8	396
C6PS2418	24x1.25x18	1.75	9	406
C6PS3018	30x1.25x18	2.0	11	432
C6PS3618	36x1.25x18	2.25	14	443
C6PS4218	42x1.25x18	2.75	16	508
C6PS4818	48x1.25x18	3.0	18	520
C6PS5418	54x1.25x18	3.25	20	556
C6PS6018	60x1.25x18	3.75	23	571
C6PS6618	66x1.25x18	4.0	25	593
C6PS7218	72x1.25x18	4.25	27	607

**SURFACE MOUNTED ARCHED SCREEN**

- Screens are 18" H at ends, 21" H at center

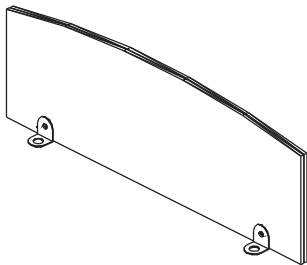

C6CS2021	20x1.25x21	1.5	8	456
C6CS2421	24x1.25x21	1.75	9	466
C6CS3021	30x1.25x21	2.0	11	491
C6CS3621	36x1.25x21	2.25	14	501
C6CS4221	42x1.25x21	2.75	16	555
C6CS4821	48x1.25x21	3.0	18	566
C6CS5421	54x1.25x21	3.25	20	597
C6CS6021	60x1.25x21	3.75	23	610
C6CS6621	60x1.25x21	4.0	25	627
C6CS7221	72x1.25x215	4.25	27	640

PRIVACY

6

Description	Model No.	Size (WxDxH)	COM Requirements (YDS)	Wt.	Price Each
-------------	-----------	--------------	------------------------	-----	------------

MODESTY SCREEN

- Modesty Screens attach to the underside of the worksurface with mounting brackets which are included with the panel.
- Modesty Screens are designed to mount 15" above the floor and the tops of the panels coincide with other system components; 27" high screens finish at 42" A.F.F., 32" high screens finish at 47" A.F.F. and 48" high screens finish at 63" A.F.F.

27" MODESTY SCREEN

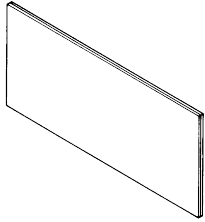

C6MS2027	20x1.25x27	1.5	12	380
C6MS2427	24x1.25x27	1.75	14	399
C6MS3027	30x1.25x27	2.0	17	411
C6MS3627	36x1.25x27	2.25	21	434
C6MS4227	42x1.25x27	2.75	24	477
C6MS4827	48x1.25x27	3.0	27	493
C6MS5427	54x1.25x27	3.25	31	512
C6MS6027	60x1.25x27	3.75	34	522
C6MS6627	66x1.25x27	4.0	38	538
C6MS7227	72x1.25x27	4.25	41	558

32" MODESTY SCREEN

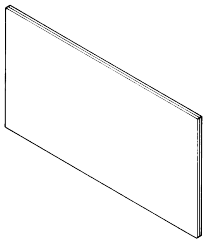

C6MS2032	20x1.25x32	1.5	13	396
C6MS2432	24x1.25x32	1.75	16	406
C6MS3032	30x1.25x32	2.0	20	432
C6MS3632	36x1.25x32	2.25	24	443
C6MS4232	42x1.25x32	2.75	28	508
C6MS4832	48x1.25x32	3.0	32	520
C6MS5432	54x1.25x32	3.25	36	556
C6MS6032	60x1.25x32	3.75	40	571
C6MS6632	66x1.25x32	4.0	44	593
C6MS7232	72x1.25x32	4.25	48	607

48" MODESTY SCREEN

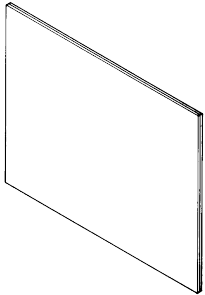

C6MS2048	20x1.25x48	1.5	20	402
C6MS2448	24x1.25x48	1.75	24	422
C6MS3048	30x1.25x48	2.0	30	488
C6MS3648	36x1.25x48	2.25	36	547
C6MS4248	42x1.25x48	2.75	42	583
C6MS4848	48x1.25x48	3.0	48	614
C6MS5448	54x1.25x48	3.25	54	649
C6MS6048	60x1.25x48	3.75	60	731
C6MS6648	66x1.25x48	4.0	66	756
C6MS7248	72x1.25x48	4.25	72	785

PRIVACY

Description	Model No.	Size (WxDxH)	COM Requirements (YDS)	Wt.	Price Each
-------------	-----------	--------------	------------------------	-----	------------

**FULL SCREENS**

· Full Screens mount to the underside of the worksurface with mounting brackets which are included with the panels.

Bases include leveling glides for additional stability.

· Alignment hardware is included with screens.

**34" FULL SCREEN**

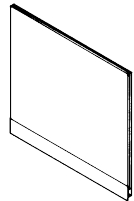

C6FS2034	20x1.25x34	1.5	15	428
C6FS2434	24x1.25x34	1.75	17	460
C6FS3034	30x1.25x34	2.0	21	486
C6FS3634	36x1.25x34	2.25	26	541
C6FS4234	42x1.25x34	2.75	30	607
C6FS4834	48x1.25x34	3.0	34	638
C6FS5434	54x1.25x34	3.25	39	719
C6FS6034	60x1.25x34	3.75	43	768
C6FS6634	66x1.25x34	4.0	47	849
C6FS7234	72x1.25x34	4.25	51	890

**40" FULL SCREEN**

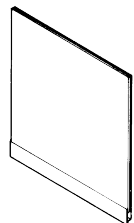

C6FS2040	20x1.25x40.5	1.5	17	445
C6FS2440	24x1.25x40.5	1.75	20	477
C6FS3040	30x1.25x40.5	2.0	26	514
C6FS3640	36x1.25x40.5	2.25	31	586
C6FS4240	42x1.25x40.5	2.75	36	656
C6FS4840	48x1.25x40.5	3.0	41	729
C6FS5440	54x1.25x40.5	3.25	52	798
C6FS6040	60x1.25x40.5	3.75	57	888
C6FS6640	66x1.25x40.5	4.0	62	940
C6FS7240	72x1.25x40.5	4.25	67	1010

**47" FULL SCREEN**

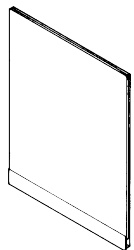

C6FS2047	20x1.25x47	1.5	20	455
C6FS2447	24x1.25x47	1.75	24	514
C6FS3047	30x1.25x47	2.0	30	603
C6FS3647	36x1.25x47	2.25	36	689
C6FS4247	42x1.25x47	2.75	42	779
C6FS4847	48x1.25x47	3.0	48	867
C6FS5447	54x1.25x47	3.25	53	930
C6FS6047	60x1.25x47	3.75	59	962

**63" FULL SCREEN**

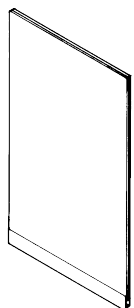

C6FS2063	20x1.25x63	3.75	27	514
C6FS2463	24x1.25x63	3.75	32	586
C6FS3063	30x1.25x63	3.75	40	692
C6FS3663	36x1.25x63	3.75	48	798
C6FS4263	42x1.25x63	3.75	56	904
C6FS4863	48x1.25x63	3.75	63	1010

PRIVACY

6

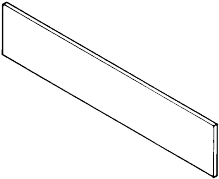
Description	Model No.	Size (WxDxH)	Wt.	Laminate w/ PVC edge	Veneer* w/ wood edge
MODESTY PANEL				(1)	(3)
<ul style="list-style-type: none"> <li>· Modesty Panels attach to the underside of the worksurface with supplied hardware.</li> <li>· Specify the finish according to the Design and Specification Guide.</li> <li>· Panels are recessed 3" from the edge of the worksurface and panels begin at 15" above the finished floor when installed.</li> <li>· Veneer panels wider than 48" have a 1<sup>1</sup>/<sub>8</sub>"x1<sup>1</sup>/<sub>8</sub>" reveal machined in the center of the panel.</li> </ul>					
MODESTY PANEL					
	C6MP1812	18x.75x12.5	7	192	354
	C6MP2412	24x.75x12.5	8	197	359
	C6MP3012	30x.75x12.5	11	207	370
	C6MP3612	36x.75x12.5	13	218	380
	C6MP4212	42x.75x12.5	15	235	437
	C6MP4812	48x.75x12.5	17	247	460
	C6MP5412	54x.75x12.5	19	255	486
	C6MP6012	60x.75x12.5	21	271	509
	C6MP6612	66x.75x12.5	23	283	534
	C6MP7212	72x.75x12.5	25	293	558
	C6MP7812	78x.75x12.5	27	303	582
	C6MP8412	84x.75x12.5	29	311	607
	C6MP9012	90x.75x12.5	32	322	631
C6MP9612	96x.75x12.5	34	333	655	

\*Note: Veneer 1 side

Description	Model No.	Size (WxDxH)	Wt.	Laminate w/PVC	Veneer* w/wood
FULL MODESTY PANEL				(1)	(3)

- Designed to fill the space between the floor and the underside of the worksurface, Full Modesty Panels are available in 3 heights.
- Panels attach to brackets mounted to the underside of the worksurface. Leveling glides are included for additional stability.
- Veneer panels wider than 48" have a 1<sup>1</sup>/<sub>8</sub>"x1<sup>1</sup>/<sub>8</sub>" reveal machined in the center of the panel.

27" FULL MODESTY PANEL

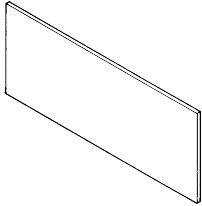

C6FM1827	18x1.5x27.5	10	180	422
C6FM2027	20x1.5x27.5	12	181	426
C6FM2427	24x1.5x27.5	13	184	427
C6FM3027	30x1.5x27.5	17	205	494
C6FM3627	36x1.5x27.5	20	222	576
C6FM4227	42x1.5x27.5	23	285	622
C6FM4827	48x1.5x27.5	27	308	688
C6FM5427	54x1.5x27.5	30	333	720
C6FM6027	60x1.5x27.5	33	354	737
C6FM6627	66x1.5x27.5	36	382	769
C6FM7227	72x1.5x27.5	40	404	786
C6FM7827	78x1.5x27.5	43	434	818
C6FM8427	84x1.5x27.5	46	450	850
C6FM9027	90x1.5x27.5	50	479	883
C6FM9627	96x1.5x27.5	53	494	916

\*Note: Veneer 1 side only

34" FULL MODESTY PANEL

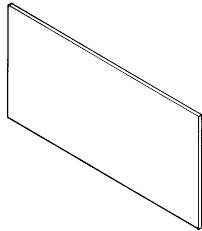

C6FM1834	18x1.5x34.5	14	197	471
C6FM2034	20x1.5x34.5	16	211	473
C6FM2434	24x1.5x34.5	19	228	476
C6FM3034	30x1.5x34.5	23	262	559
C6FM3634	36x1.5x34.5	28	289	640
C6FM4234	42x1.5x34.5	32	366	720
C6FM4834	48x1.5x34.5	37	398	769
C6FM5434	54x1.5x34.5	41	434	801
C6FM6034	60x1.5x34.5	46	466	834
C6FM6634	66x1.5x34.5	50	504	866
C6FM7234	72x1.5x34.5	55	539	898
C6FM7834	78x1.5x34.5	59	580	931
C6FM8434	84x1.5x34.5	64	608	964
C6FM9034	90x1.5x34.5	68	649	996
C6FM9634	96x1.5x34.5	73	674	1028

\*Note: Veneer 1 side only

PRIVACY

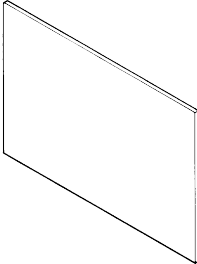

6

Description	Model No.	Size (WxDxH)	Wt.	Laminate w/PVC (1)	Veneer* w/wood (3)
<b>40" FULL MODESTY PANEL</b>					
	C6FM1840	18x1.5x40.5	16	222	509
	C6FM2040	20x1.5x40.5	19	238	519
	C6FM2440	24x1.5x40.5	21	261	525
	C6FM3040	30x1.5x40.5	26	302	622
	C6FM3640	36x1.5x40.5	32	337	737
	C6FM4240	42x1.5x40.5	37	422	801
	C6FM4840	48x1.5x40.5	42	462	931
	C6FM5440	54x1.5x40.5	47	506	964
	C6FM6040	60x1.5x40.5	52	547	996
	C6FM6640	66x1.5x40.5	58	593	1029
	C6FM7240	72x1.5x40.5	63	637	1060
	C6FM7840	78x1.5x40.5	68	686	1093
	C6FM8440	84x1.5x40.5	73	720	1126
	C6FM9040	90x1.5x40.5	78	768	1158
C6FM9640	96x1.5x40.5	84	807	1190	

\*Note: Veneer 1 side only

**TACK PANEL**

- Tack Panels are finished on the face side only.
- Panels have velcro strips attached to the back for wall mounting and mounting hardware for attaching between Upper Storage Units and Worksurfaces.

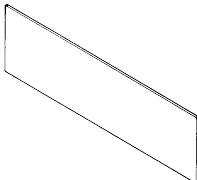
TACK PANEL	Model No.	Size (WxDxH)	Wt.	COM. Requirements (YDS)	Price Each
	C6TP2018	20x.75x18	.75	5	194
	C6TP2418	24x.75x18	1.0	6	203
	C6TP3018	30x.75x18	1.0	7	211
	C6TP3618	36x.75x18	1.25	8	218
	C6TP4218	42x.75x18	1.5	10	235
	C6TP4818	48x.75x18	1.5	11	250
	C6TP5418	54x.75x18	1.75	12	259
	C6TP6018	60x.75x18	2.0	13	267
	C6TP6618	66x.75x18	2.0	15	274
	C6TP7218	72x.75x18	2.25	16	283

**DOUBLE SIDED TACK PANEL**

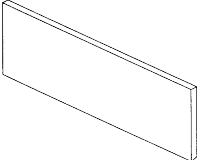
	C6DT2018	20x1.25x18	1.5	8	396
	C6DT2418	24x1.25x18	1.75	9	406
	C6DT3018	30x1.25x18	2.0	11	432
	C6DT3618	36x1.25x18	2.25	14	443
	C6DT4218	42x1.25x18	2.75	16	508
	C6DT4818	48x1.25x18	3.0	18	520
	C6DT5418	54x1.25x18	3.25	20	556
	C6DT6018	60x1.25x18	3.75	23	571
	C6DT6618	66x1.25x18	4.0	25	593
	C6DT7218	72x1.25x18	4.25	27	607

PRIVACY

C O U N T E R P O I N T P R I C E L I S T

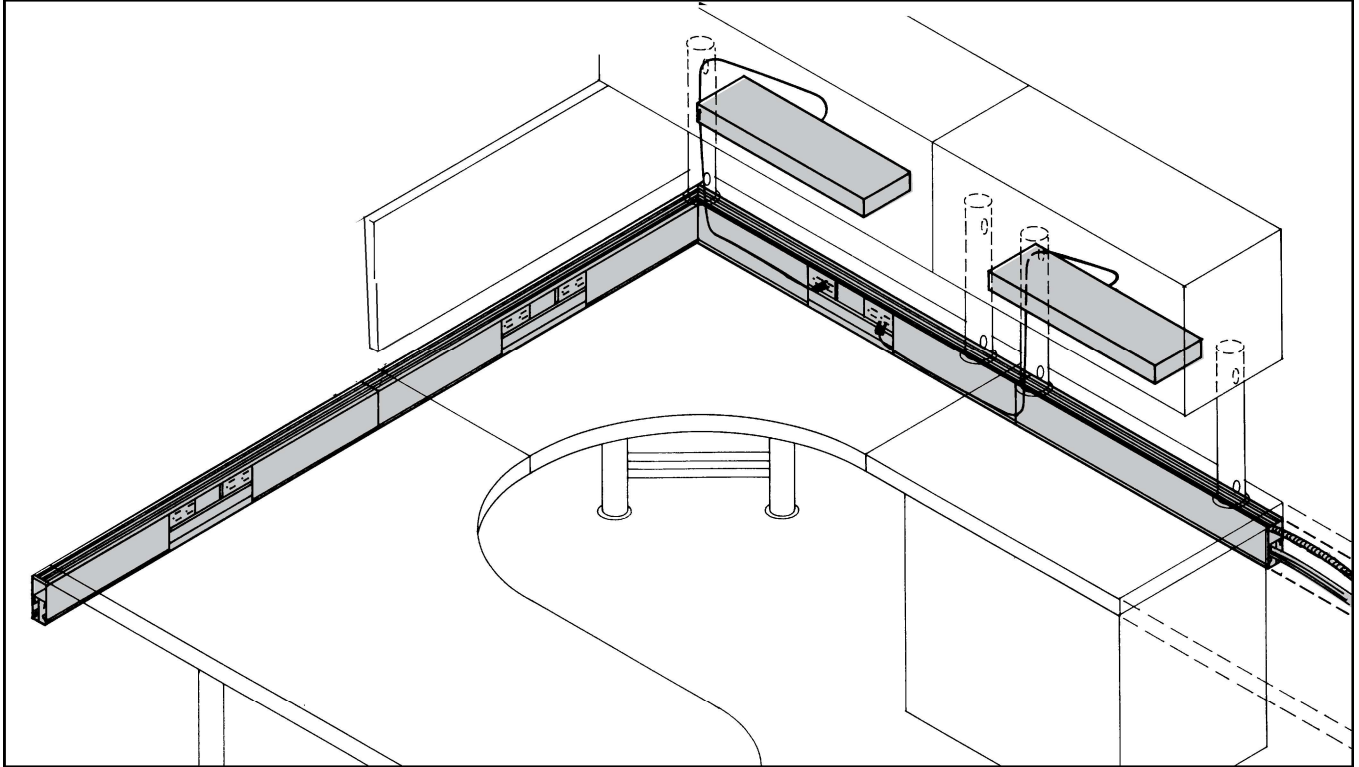

#### GENERAL SPECIFICATIONS

- Electrical System Components are available in lengths corresponding to the width of the worksurfaces to which they are attached. Duplex receptacles are located in the center portion of the unit. As a rule of thumb, locations of the duplexes should be within 72" of the location of the device which they power.
- Pass Through Cables and Power Boxes include Wire Management Tracks as part of the unit. Wire Management Tracks must be ordered separately for Power Entry Cables.
- Wire Management Tracks are black PVC and are mounted to the underside of the worksurface flush with the back edge.
- When ordering Electrical System Components, a furniture plan must be provided with the order. Special conditions which require specific hardware such as corners, finished and exposed ends or power poles should be noted on the plan.
- Paper Management Accessories are designed for use with screen beams and can be mounted to interior walls or fabric covered screens. Accessories are black powder coated finish. See Design and Specification Guide for quantities of accessories which can be mounted on beams and open screens.

Description	Model No.	Size (WxDxH)	Wt.	Price Each
-------------	-----------	--------------	-----	------------

**TASK LIGHTS**

- Under cabinet Task Lights can be mounted to the underside of the Upper Storage.
- Cord management is handled through the support post with the plug end exiting under the worksurface.
- Energy efficient Octron™ fluorescent bulbs are included with each light.
- Standard finish is black powdercoat.

UNDERCABINET TASK LIGHT	C7TL48	48x7x2	12	283
-------------------------	--------	--------	----	-----

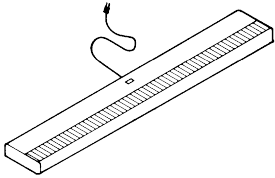

UNDERCABINET TASK LIGHT	C7TL24	24x7x2	9	259
-------------------------	--------	--------	---	-----

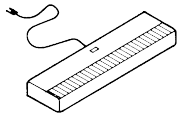

Description	Model No.	Size (WxDxH)	Wt.	Price Each
-------------	-----------	--------------	-----	------------

**POWER ENTRY KIT**

- The Power Entry Kit is used to attach the CounterPoint electrical component system to the building power.
- Consult local building code requirements regarding electrical specifications. Attaching the Power Entry Kit to the building power source requires a licensed electrician.
- A Ceiling Power Entry Kit may require use of a power pole or additional wire management device. Consult the factory for suggested components.

POWER ENTRY KIT	C7PE72	72"	3	276
	Ceiling C7PE15C	15'	3	225
	(Power pole not included)			



Description	Model No.	Size (WxDxH)	Wt.	Price Each
-------------	-----------	--------------	-----	------------

**POWER BOX**

- Specify the Power Box in lengths which correspond to the edge of the worksurface to which the unit is attached.
- See the Design and Specification Guide for complete information regarding specification requirements for electrical system components. Consult with a factory representative for guidance on specific projects.

Outlets per side

**POWER BOX W/DUPLEX  
OUTLETS — 1 SIDED**

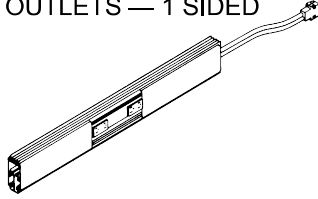

C7PB24	24x2.5x5	6	274	1
C7PB30	30x2.5x5	8	322	2
C7PB36	36x2.5x5	9	352	2
C7PB42	42x2.5x5	11	382	2
C7PB48	48x2.5x5	12	415	2
C7PB54	54x2.5x5	14	429	2
C7PB60	60x2.5x5	15	440	2
C7PB66	66x2.5x5	17	510	2
C7PB72	72x2.5x5	18	525	2

**POWER BOX W/DUPLEX  
OUTLETS — 2 SIDED**

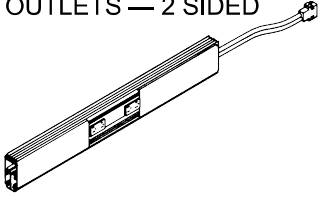

C7PB24/2	24x2.5x5	6	303	1
C7PB30/2	30x2.5x5	8	351	2
C7PB36/2	36x2.5x5	9	380	2
C7PB42/2	42x2.5x5	11	410	2
C7PB48/2	48x2.5x5	12	443	2
C7PB54/2	54x2.5x5	14	466	2
C7PB60/2	60x2.5x5	15	504	2
C7PB66/2	66x2.5x5	17	538	2
C7PB72/2	72x2.5x5	18	553	2

**PASS THROUGH CABLE**

- Specify Pass Through Cables in lengths which correspond to the edge of the worksurface to which the unit is attached.
- See the Design and Specification Guide for complete information regarding specification requirements for electrical system components. Consult with a factory representative for guidance on specific projects.

**PASS THROUGH CABLE**

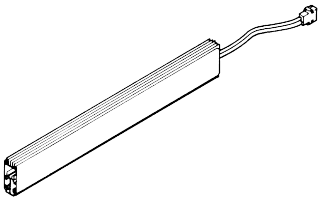

C7PT24	24x2.5x5	6	154
C7PT30	30x2.5x5	8	169
C7PT36	36x2.5x5	9	185
C7PT42	42x2.5x5	11	200
C7PT48	48x2.5x5	12	217
C7PT54	54x2.5x5	14	235
C7PT60	60x2.5x5	15	248
C7PT66	66x2.5x5	17	267
C7PT72	72x2.5x5	18	286

Description	Model No.	Size (WxDxH)	Wt.	Price Each
-------------	-----------	--------------	-----	------------

**WIRE MANAGEMENT TRACKS**

- Wire Management Tracks can be used with or without the electrical component system.
- The track consists of four parts:
  1. Mounting track.
  2. Management cells.
  3. Cover plate.
  4. Mounting screws.
- Specify wire management tracks in lengths which correspond to the edge length of the worksurface to which the unit is attached.
- Units are individually packaged and must be field assembled when installed.

**WIRE MANAGEMENT TRACKS**

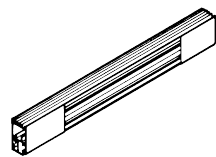

C7WM24	24x2.5x5	4	83
C7WM30	30x2.5x5	5	102
C7WM36	36x2.5x5	6	124
C7WM42	42x2.5x5	7	143
C7WM48	48x2.5x5	8	163
C7WM54	54x2.5x5	9	185
C7WM60	60x2.5x5	10	204
C7WM66	66x2.5x5	11	225
C7WM72	72x2.5x5	12	245

**T-Box**

- Specify the power box in lengths which correspond with the width of the panel or worksurface to which the unit is attached.
- See the Design and Specification Guide for complete information regarding specification requirements for electrical system components. Consult with a factory representative for guidance on specific projects.
- For Panel Mounted situations place a "PM" after the model number (ex: C7JB24PM).
- For worksurface mounted situations place a "WS" after the model number (ex: C7JB24WS).

# Outlets

**T-BOX WITH DUPLEX OUTLETS**

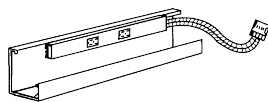

C7JB24	24x2.5x5	6	238	1
C7JB30	30x2.5x5	8	280	2
C7JB36	36x2.5x5	9	304	2
C7JB42	42x2.5x5	11	330	2
C7JB48	48x2.5x5	12	360	2
C7JB54	54x2.5x5	14	382	2
C7JB60	60x2.5x5	15	414	2
C7JB66	66x2.5x5	17	443	2
C7JB72	72x2.5x5	18	457	2

**PASS THROUGH CABLE**

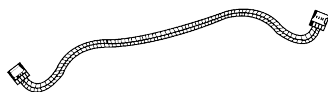

C7JC24	24" LONG	4	154
C7JC30	30" LONG	5	169
C7JC36	36" LONG	6	185
C7JC42	42" LONG	7	200
C7JC48	48" LONG	8	218
C7JC54	54" LONG	9	235
C7JC60	60" LONG	10	248
C7JC66	66" LONG	11	267
C7JC72	72" LONG	12	286

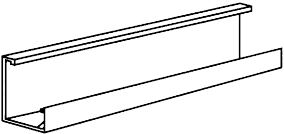
Description	Model No.	Size (WxDxH)	Wt.	Price Each
PASS THROUGH CABLE MANAGEMENT TRACK  	C7TM24	24x2.5x5	4	76
	C7TM30	30x2.5x5	5	98
	C7TM36	36x2.5x5	6	117
	C7TM42	42x2.5x5	7	136
	C7TM48	48x2.5x5	8	154
	C7TM54	54x2.5x5	9	174
	C7TM60	60x2.5x5	10	194
	C7TM66	66x2.5x5	11	213
C7TM72	72x2.5x5	12	234	

PVC WIRE MANAGER

- Units can be field cut to custom lengths.
- The PVC Wire Manager mounts to a panel or worksurface with common wood screws. Screws are not included.

PVC WIRE MANAGER	C7JM48	48x2.5x1.5	1	46
------------------	--------	------------	---	----



POWER GROMMET

- The Power Grommet comes with a 6' cord and a standard three prong plug.
- It extends 5.25" above worksurface when fully open.
- For factory installation, a furniture plan with specific locations for grommets must be included with your order.

POWER GROMMET W/ OPTIONAL DATA				
	C7PG10	4.25x2.75x8.5	3	297
Factory installed	C7PG50	4.25x2.75x8.5	3	322
ADD (-A) TO RECEIVE (1) RJ11 VOICE + (1) RJ45 DATA PORT ADD (-B) TO RECEIVE (2) RJ11 VOICE PORTS ADD (-C) TO RECEIVE (2) RJ45 DATA REPORTS				

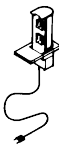

PASS THROUGH GROMMET

- For factory installation, a furniture plan with specific locations for grommets must be included with your order.

PASS THROUGH GROMMET					
	Field installed	C7TG10	2.5" DIA	1	26
	Factory installed	C7TG50	2.5" DIA	1	42



COMPUTER GROMMET

	Field Installed	C7CG10	3" DIA	1	40
	Factory installed	C7CG50	3" DIA	1	59



COMPUTER PAPER GROMMET

- For factory installation, a furniture plan with specific locations for grommets must be included with your order.

COMPUTER PAPER GROMMET					
		C7WA10	18x2.5x75	1	25
	Factory installed	C7WA50	18x2.5x75	1	49

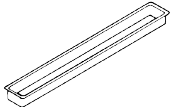

Description	Model No.	Size (WxDxH)	Wt.	Price Each
-------------	-----------	--------------	-----	------------

METAL PENCIL DRAWER

C7DA20-4	20x18x2	10	213
----------	---------	----	-----

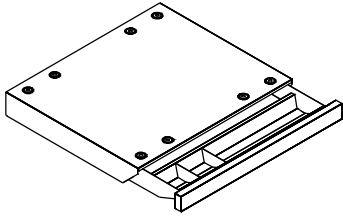

Price Each

PENCIL TRAY

C7DA12	12x5.5x1	1	19
--------	----------	---	----

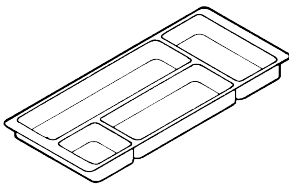

ARTICULATING KEYBOARD TRAY

C7KT20	20x17.5x3.5	15	238
--------	-------------	----	-----

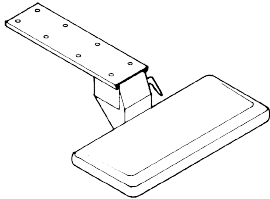

TRAY W/ KEYBOARD MOUSE PAD EXTENSION

C7KM20	20x17.5x3.5	18	340
--------	-------------	----	-----

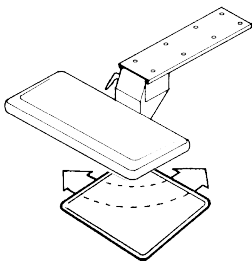

MOUSE PAD EXTENSION

C7MP10	8x8x.5	3	102
--------	--------	---	-----

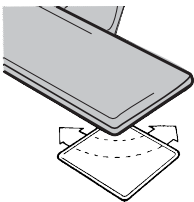



7

Description	Model No.	Size (WxDxH)	Wt.	Price Each
WORKSURFACE JOINING PLATE	C7HP3	3X3	1	25



Z-BRACKET				
· Brackets attach to worksurfaces with pan head screws which are included with each unit.				
· The Z-bracket reduces the worksurface height to 26" A.F.F. (typing height).				

Z-BRACKET	C7ZB18	16x5x3	2	32
-----------	--------	--------	---	----

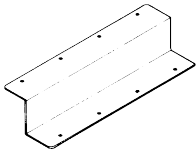

CPU HOLDER	C7VH12	5x12x*	8	119
------------	--------	--------	---	-----

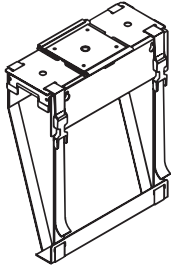

\*Adjustable height.

VERTICAL WIRE MANAGER	C7VM30	30x2.5DIA	1	96
-----------------------	--------	-----------	---	----



Description	Model No.	Size (WxDxH)	Wt.	Price Each
-------------	-----------	--------------	-----	------------

**LOCK**

- Specify keying requirements when ordering. Lock cores can be shipped separately for field installation if desired.
- Cam style lock used to lock doors on upper storage units and building towers. On two door units, the lock is installed in the right hand door and the left door latches with an interior catch.

**LOCK**

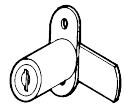

	C7RL10		1	49
Factory installed	C7RL50		1	64

**REPLACEMENT KEY**

- Specify the key and lock number when ordering.

**REPLACEMENT LOCK CORE**

- Specify the key and lock number when ordering.
- Specify the the product model number that the replacement lock will be used with.
- Installation requires special core insertion tool which must be requested when ordering.
- Two keys are included.

**REPLACEMENT LOCK CORE & KEY**

	C7LC10		1	13
--	--------	--	---	----



**CHANGE OUT KEY**

- Specify whether the lock is in a metal or laminate product.

	C7CK10		1	33
--	--------	--	---	----



7

Description	Model No.	Size (WxDxH)	Wt.	Price Each
-------------	-----------	--------------	-----	------------

SCREEN BEAM

- Screen Beams are used to support paper management accessories and are designed to be mounted to CounterPoint screens or interior walls.
- All required brackets are included with each beam. Wall mount hardware which is appropriate for site conditions is the responsibility of the specifier to provide.

SCREEN BEAM

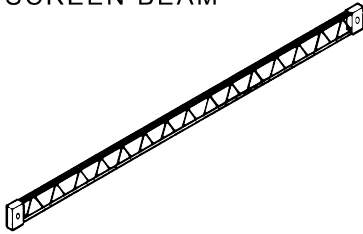

C7SB18	18x.75x2.25	3	98
C7SB20	20x.75x2.25	3	98
C7SB24	24x.75x2.25	3	99
C7SB30	30x.75x2.25	3	105
C7SB36	36x.75x2.25	4	109
C7SB42	42x.75x2.25	4	124
C7SB48	48x.75x2.25	5	131
C7SB54	54x.75x2.25	5	150
C7SB60	60x.75x2.25	6	170

STORAGE SHELF

- The Storage Shelf mounts to a screen beam.

STORAGE SHELF

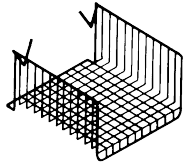

C7SV3	12.25x12.5x8	3	79
-------	--------------	---	----

VERTICAL BINDER ORGANIZER

- The Vertical Binder Organizer mounts on a screen beam and is used to hold binders, notebooks, large mailing envelopes, etc.

VERTICAL BINDER ORGANIZER

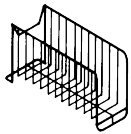

C7VP11	4x12.5x8	3	65
--------	----------	---	----

Description	Model No.	Size (WxDxH)	Wt.	Price Each
-------------	-----------	--------------	-----	------------

**DIAGONAL LETTER ORGANIZER**

- The Diagonal Letter Organizer mounts on a screen beam and is used to hold letters, envelopes, etc.
- It can be reversed for either a right or left hand slant.

DIAGONAL LETTER ORGANIZER	C7DP11	3.5x12x8.5	2	53
---------------------------	--------	------------	---	----

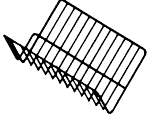

**DIAGONAL LEGAL ORGANIZER**

- The Diagonal Legal Organizer mounts on a screen beam and is used to hold legal size materials, etc.
- It can be reversed for either a right or left hand slant.

DIAGONAL LEGAL ORGANIZER	C7DP14	3.5x15x8.5	2	55
--------------------------	--------	------------	---	----

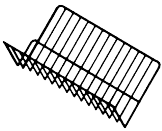

**IN / OUT TRAYS**

- Two trays (one unit) hang on a screen beam and are used to organize letters, envelopes, small packages, etc. into respective "IN", "OUT" or "HOLD" categories. Items lie flat.

IN / OUT TRAYS	C7IT9	12.5x9x8	3	124
----------------	-------	----------	---	-----

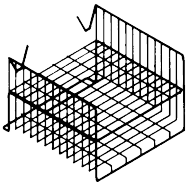



---

Applications: Worksurfaces  
 Door and drawer faces  
 Full Modestly Panels

#### LAMINATE

High pressure laminates from solids to optical solids to patterns to woodgrains. Specify colorful and durable laminates to coordinate with veneer, edgebanding and fabric. CounterPoint offers all standard finish, non-gloss laminates from Wilsonart, Pionite, Nevemar and Formica.

#### PVC 2MM

Thick 2mm PVC Edgebanding. High impact resistant and aesthetic appeal make four standard PVC edges functional and affordable.

C-596 BLACK	(PIONITE SE-1015 BLACK)
C-495 FOG	(FORMICA 961-58 FOG)
C-565 FOLKSTONE	(PIONITE SG2415 FOLKSTONE)
C-192 BEIGE	(NEVEMAR 5-2 63T NATURAL BEIGE)

---

Applications: Modesty screens  
 Surface mounted privacy  
 Tack boards

#### FABRIC

All panel fabric offerings from Guilford of Maine and CF Stinson are available as standard.

Contact Guilford of Maine for samples: 1-800-544-0200

Contact CF Stinson for samples: 1-800-841-6279

---

Applications: Worksurfaces  
Door and drawer faces

### COMPOSITE VENEER

Consistent color, grain pattern and quality are the keys to the CounterPoint veneer program. Six colors are standard in CounterPoint.

C 747 MAPLE  
C 323 ASH  
C 921 CHERRY  
C 269 LIGHT OAK

### VENEER 2MM

Thick 2mm veneer edgebanding has been selected for aesthetics and function. Match to composite veneers or use in conjunction with high pressure laminate.

C 747 MAPLE  
C 323 ASH  
C 921 CHERRY  
C 269 LIGHT OAK

---

Applications: Architectural supports (upper and lower)  
Handles  
Locks  
Structural hardware

### POWDER COAT FINISH

Tough fused – powder metal coating is standard on all metal parts.  
Finished in Satin Black only.



---

#### Order Information

All orders are to be in writing to avoid errors and/or duplication. Orders are accepted subject only to the terms and conditions listed hereunder. It is expressly understood that variation from these terms and conditions shall only pertain on a per order basis when agreed to in writing by an officer of HLF Furniture, Incorporated. In placing an order, customer unconditionally agrees that terms and conditions listed hereinunder shall supercede any and all terms or conditions listed on the customer's purchase order.

---

#### Phone Orders

Phone orders must be followed by written confirmation via mail or FAX transmission. It is the customer's responsibility to clearly indicate confirmation to avoid duplication.

---

#### Acknowledgement

It is our policy to acknowledge all orders in writing. The Acknowledgement will reflect as completely as possible our understanding of the order and will indicate the correct net pricing and approximate ship date. It remains the customer's responsibility to check the Acknowledgement for accuracy and to promptly report any errors or discrepancies.

---

#### Date of Delivery

It is our firm intention to comply with requested delivery dates insofar as is reasonably possible; however, it should be recognized that the date of shipment listed on our Acknowledgement is an estimate only and not an essential term of agreement. Delays in shipment of an order do not constitute a valid reason for cancellation nor shall HLF be liable for any expenses arising from any delay in delivery or failure to make delivery due to unavailability of raw materials, labor, or supplies or any factor beyond our reasonable control which might hinder or impede the manufacture or delivery of all or part of any order accepted.

---

#### Cancellations/Changes

Orders may be cancelled or changed at any time prior to commencement of production. The customer will be responsible for any costs incurred up to the point of cancellation and for the cost of any changes. No cancellations or changes will be accepted after production has commenced.

---

#### Prices

All prices are subject to change without notice. Orders are accepted at the price in effect as of the date of receipt of order at the factory.

---

#### Terms

Terms are 1% 10 days/net 30 days for customers on open account. Open account is only granted upon approval of a completed HLF Credit Application by our credit department. A 50% deposit or Pro Forma payment may be required prior to processing an initial order. Terms on customer items are 50% deposit/balance net, regardless of credit status. No orders will be processed for accounts having outstanding invoices more than 30 days past due.

---

#### Specifications

Sizes, as listed, are nominal and may vary plus or minus 1/2" from list. Where product construction and material specifications are listed in this price list, they represent materials and methods in use at the time this guide was printed. HLF unconditionally reserves the right to change materials and construction methods without notice as part of our continuing efforts to improve products and techniques. HLF does not manufacture plastic laminates. Specifications for plastic laminate should be obtained directly from the appropriate laminate manufacturers.

---

#### Returns/Restocking

No returns will be accepted without the prior written consent of the factory. As all goods are manufactured to order, there is no provision offered for restocking merchandise upon payment of a restocking charge.

---

### Warranty

All CounterPoint™ products are warranted to the original purchaser for a period of five years from the date of the original invoice to be free from factory defects in workmanship or materials. Because of natural variations over which HLF has no control, this warranty does not extend to color, grain or texture of wood or textiles and does not warrant matching of color grain or texture except as specified in the order confirmation.

HLF assumes no responsibility for the improper application or installation of electrical and lighting components, or for labor costs involved in repair or replacement. Lamps, ballasts, sockets or other electrical components not fully manufactured by HLF are covered by manufacturer's trade warranties.

HLF Furniture's sole obligation and customer's remedy under this warranty shall extend to the repair or replacement, at our option, of products which prove defective during the warranty period under normal usage for the purpose intended. Misuse, alteration, negligence, abuse or damage by accident shall negate this warranty. There are no implied warranties of merchantability or fitness for a particular purpose made by HLF in connection with the sale or use of any item. The warranty provisions listed above are expressly in lieu of any other warranties, express or implied by fact or by statute, and all other remedies for damages arising from the sale or use of any item of furniture.

---

### Backcharges

Charges incurred by the customer in expediting shipments or for the repair of goods will not be accepted by the company. Any back charges must be approved in advance in writing by HLF Furniture, Inc. via an HLF Credit Memo. We reserve the right to return goods to the factory for warranty repair rather than incur field service costs and shall be liable only for costs between the factory and the destination to which the goods were first delivered as indicated on our Shipper or Bill of Lading.

---

### Drop Shipment

Customers desiring drop shipment may arrange for merchandise to be delivered to a local transfer agent capable of delivery to the end-user. Zone 1 customers desiring drop shipment to a destination other than their own immediate geographic area should consult the factory for possible crating charges.

---

### Packaging/Crating

All CounterPoint™ products are shipped blanket wrapped, whenever possible. Packaging and/or crating is available. Consult factory for pricing.

---

### Claims

Regarding shipments made via common carrier. We take great care in the handling of our finished product. All shipments are delivered to the transportation company in good condition and our liability ceases at that time. We strongly suggest that all merchandise be inspected immediately upon delivery to avoid any possible concealed freight damage. If a shipment is received damaged or short, the shipping receipt should note these damages or shortages. A freight claim should be filed immediately with the transportation company.

---

### Storage/Delays

When shipment is delayed by the customer, we reserve the right to place the goods in storage at the customer's risk and expense. Terms for payment shall commence upon notification of the customer that goods are ready for pick-up or delivery.





---

Shipping Zones

All shipments are either common or contract carrier, at the factory's discretion.

Zone 1

For orders exceeding \$2500 net, pricing includes the freight cost to your location.  
For orders less than \$2500 net, add a \$75 drop charge.

Zone 2

For orders exceeding \$2500 net, pricing includes the freight cost to your location.  
For orders less than \$2500 net, add a \$125 drop charge.

Zone 3

For orders exceeding \$2500 net, pricing includes the freight cost to your location.  
For orders less than \$2500 net, add a \$175 drop charge.

Zone 4

For orders exceeding \$2500 net, pricing includes the freight cost to your location.  
For orders less than \$2500 net, add a \$175 drop charge.

Consult factory for discount information and to confirm which zone is being shipped to.





HLF Furniture, Inc.

44001 Van Born Road Belleville, MI 48111

734-699-7100 Fax: 734-697-3008

[www.hlffurniture.com](http://www.hlffurniture.com)

